

# Rover Li Series

## MPPT Solar Charge Controller

12V/24V | 20A/30A/40A

VERSION A6

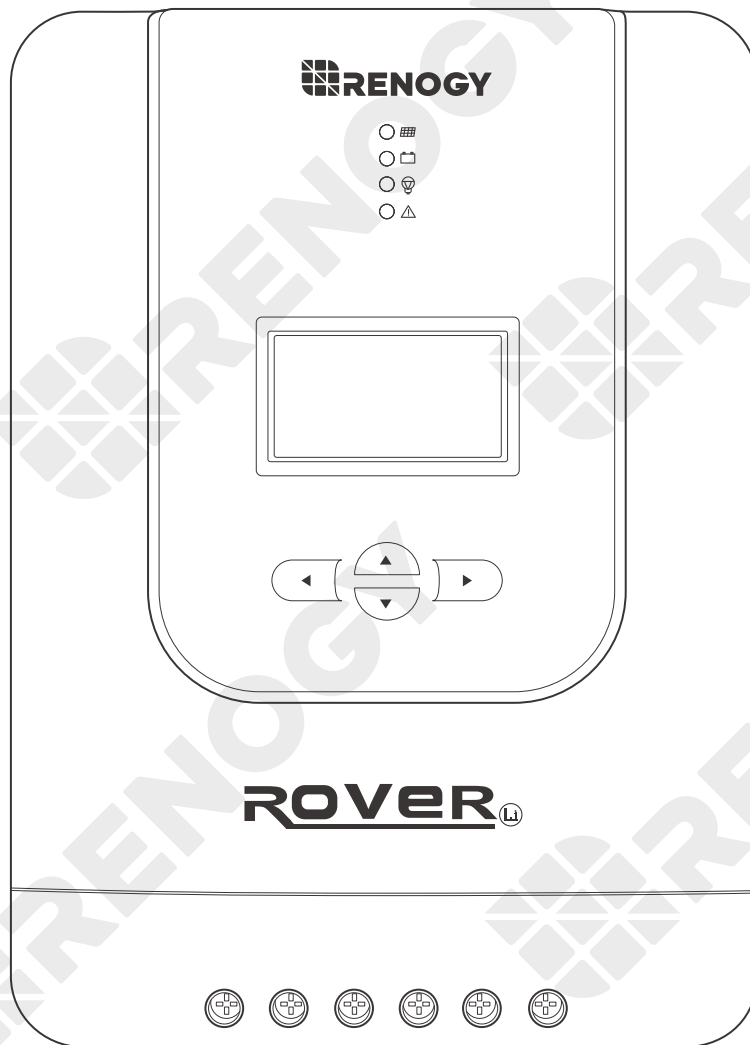

USER MANUAL

## Applicability

The user manual applies to the following products:

- Rover Li 12V/24V 20A MPPT Solar Charge Controller (RNG-CTRL-RVR20)
- Rover Li 12V/24V 30A MPPT Solar Charge Controller (RNG-CTRL-RVR30)
- Rover Li 12V/24V 40A MPPT Solar Charge Controller (RNG-CTRL-RVR40)

## Disclaimer

- Renogy ensures the accuracy, sufficiency, and the applicability of information in the user manual at the time of printing due to continual product improvements that may occur.
- Renogy assumes no responsibility or liability for personal and property losses, whether directly and indirectly, caused by the user's failure to install and use the product in compliance with the user manual.
- Renogy is not responsible or liable for failures, damages, or injuries resulting from repair attempted by unqualified personnel, improper installation and operation.
- The illustrations in the user manual are for demonstration purposes only. Details may appear slightly different depending on product revision and market region.
- Renogy reserves the right to change the information in the user manual without notice. For the latest user manual, visit [renogy.com](https://www.renogy.com).

## Copyright

Rover Li Series MPPT Solar Charge Controller User Manual © 2022 Renogy. All rights reserved. All information in the user manual is subject to copyright and other intellectual property rights of Renogy and its licensors. The user manual may not be modified, reproduced, or copied, in whole or in part, without the prior written permissions of Renogy and its licensors.

## Trademark

The following are registered trademarks of Renogy:

RENOGY	<b>RENOGY</b>
--------	---------------

The registered trademarks in the user manual are the property of Renogy. The unauthorized use of the trademarks is strictly prohibited.

## Date and Revision

January 2023, Revision A6

# Table of Contents

Important Safety Information .....	01
Symbols Used .....	01
General Safety Information .....	01
Introduction.....	03
General Information .....	03
Key Features .....	03
Charging and Activation Logic.....	04
MPPT Technology .....	04
Four Charging Stages .....	05
Lithium Battery Activation .....	07
Package Contents .....	08
Optional Accessories .....	09
Product Overview .....	10
Wiring Diagram.....	11
Recommended Cable and Fuse Sizing.....	12
Recommended Cable Sizing.....	12
Recommended Fuse Sizing .....	13
Components & Tools .....	14
Preparation .....	15
Inspection .....	15
Environment .....	15
Placement .....	16
Checking Battery .....	17
Checking Solar Panel.....	18
Mounting.....	20
Wall-mounted .....	20

Mounting with Brackets .....	22
Installation .....	24
Battery Wiring.....	24
Solar Wiring.....	27
Load Wiring (Optional) .....	30
Temperature Sensor .....	33
Bluetooth Module (Optional).....	34
Battery Type .....	36
Setting the Battery Type.....	36
Battery Charging Parameters.....	37
User Mode.....	38
System Voltage.....	45
Monitoring.....	47
Monitoring Menu .....	47
Checking Parameters.....	51
Load Control.....	52
Turning Load On / Off.....	52
Switching Load Mode .....	52
LED Indicators .....	55
Solar Panel LED Indicator .....	55
Battery LED Indicator .....	56
Load LED Indicator .....	56
System Error LED Indicator .....	56
Troubleshooting.....	57
Common Faults.....	57
Error Codes.....	59
Technical Specifications .....	62
MPPT Conversion Efficiency .....	64

Dimensions.....	65
RNG-CTRL-RVR20.....	65
RNG-CTRL-RVR30 or RNG-CTRL-RVR40.....	66
Maintenance.....	67
Inspection.....	67
Cleaning.....	67
Storage.....	67
Emergency Responses.....	68
Fire.....	68
Flooding.....	68
Smell.....	68
Noise.....	68
Technical Support.....	69

# Important Safety Information





Symbols Used

General Safety Information

The user manual provides important installation, operation, and maintenance instructions for Rover Li Series Solar Charge Controller (hereinafter referred to as charge controller). Read the user manual carefully before installation and operation and save it for future reference. Failure to observe the instructions or precautions in the user manual can result in electrical shock, serious injury, or death, or can damage the charge controller, potentially rendering it inoperable. The installation and service of the charge controller might require knowledge of electricity and is recommended to be carried out by qualified personnel.

## Symbols Used

The following symbols are used throughout the user manual to highlight important information:

	<b>WARNING</b>	Indicates a potentially dangerous condition which could result in injury or death
	<b>CAUTION</b>	Indicates a critical procedure for safe and proper installation and operation
	<b>NOTE</b>	Indicates an important step or tip for optimal performance
	<b>INFO</b>	Indicates that more information is available in other documents relating to the subject

## General Safety Information

### **WARNING**

- Do not puncture, drop, crush, penetrate, shake, strike, or step on the charge controller.
- Do not open, dismantle, repair, tamper with, or modify the components of the charge controller.
- Install the charge controller on a vertical surface indoors protected from direct sunlight, high temperature, and water. Make sure there is good ventilation.
- Do not immerse the charge controller or its components in water or other fluids.
- Keep the charge controller away from heating equipment.
- Do not insert foreign objects into the charge controller.
- Risk of explosion! Never install the charge controller in a sealed enclosure with flooded batteries! Do not install in a confined area where battery gases can accumulate.
- Confirm the polarities of the devices before connection. A reverse polarity contact will result in abnormalities.
- Refer to [Recommended Cable and Fuse Sizing](#) in this user manual, and select the appropriate cables and fuses according to the usage.
- Keep the charge controller out of the reach of children.

# Important Safety Information

Symbols Used

General Safety Information

- Wear proper protective equipment and use insulated tools during installation and operation.
- Do not touch the connector contacts when the charge controller is in operation.
- Disconnect all connectors from the charge controller before maintenance or cleaning.
- Do not dispose of the charge controller as household waste. Comply with local, state, and federal laws and regulations and use recycling channels as required.
- In the event of fire, use fire extinguishers suitable for electrical equipment.
- If the charge controller is installed improperly on a boat, it may cause damage to the corrosive agents of the boat. Please have the charge controller by a qualified electrician.



## CAUTION

- Do not expose the charge controller to flammable or harsh chemicals or vapors.
- Ensure that there is no water source including downspouts, sprinkles, or faucets above or near the charge controller.
- Ensure that the battery pack is properly connected before installation.

# Introduction

General Information

Key Features

## General Information

Rover Li Series MPPT Solar Charge Controller can serve various off-grid solar systems. With the adoption of intelligent MPPT (Maximum Power Point Tracking) algorithm, the charge controller can maximize the energy from the solar panel to charge the battery in a more efficient way. At the same time, it monitors the status of the battery in real time and prevents the battery from overcharge and overdischarge, thus extending the battery life and improving the performance of the system.

Rover Li Series MPPT Solar Charge Controller provides intelligent self-diagnosis and multiple input protection mechanisms, which can prevent damage caused by installation errors or system failures.

## Key Features

- **Auto Battery Voltage Detection**

The charge controller detects 12V or 24V DC system voltages for non-lithium batteries and programmability for lithium batteries.

- **MPPT Technology**

The charge controller supports advanced MPPT technology with tracking efficiency up to 99% and peak conversion efficiency of 98%.

- **High Battery Compatibility**

The charge controller is compatible with AGM, SLD, flooded, gel, lithium, and user-defined batteries.

- **Full System Protection**

The full system protection is meant to safeguard your system, and the self-diagnostic capability can assess and protect against reverse polarity, battery overcharging, battery overdischarging, overload, short-circuiting, and reverse current.

- **Multiple Input Protection Features**

The charge controller offers reverse polarity protection, overvoltage protection, short circuit protection, and reverse charging protection at night for solar panels.

- **Diverse Load Control**

You can connect DC appliances directly to the optional Load Terminals and monitor consumption or set up timer controls directly from the charge controller.



# Charging and Activation Logic

## MPPT Technology

Based on MPPT technology, the charge controller can extract maximum power from the solar panel. With an automatic tracking algorithm, the MPPT technology can track the voltage of the maximum power point that changes with weather conditions, ensuring the harvest of the maximum power throughout the day.

### ■ Current Boost

Generally, the charge controller will “boost” the current in the solar system. The power generated in the solar panel is the same as the power delivered to the battery pack. Power is the product of voltage (V) x amperage (A).

Therefore, assuming 100% efficiency:

$$\begin{aligned} \text{Power In} &= \text{Power Out} \\ \text{Volts In} * \text{Amps In} &= \text{Volts Out} * \text{Amps Out} \end{aligned}$$

The efficiency of the charge controller is about 95%. As the maximum power point voltage of the solar system is greater than the battery pack voltage, the potential difference is proportional to the current boost. The voltage of the solar panel needs to be stepped down to a rate at which the battery can be charged in a stable manner. Compared with traditional charge controllers, the charge controller does not waste the stepped down voltage. It is entirely possible to have the solar module input 8 amps of current into the charge controller, and have the charge controller output 10 amps of current to the battery pack. The following shows a graphic point about the output of MPPT technology.

**Current vs. Voltage (12V System)**

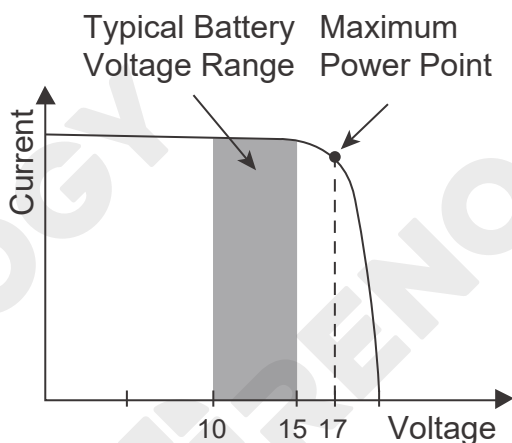

**Output Power (12V System)**

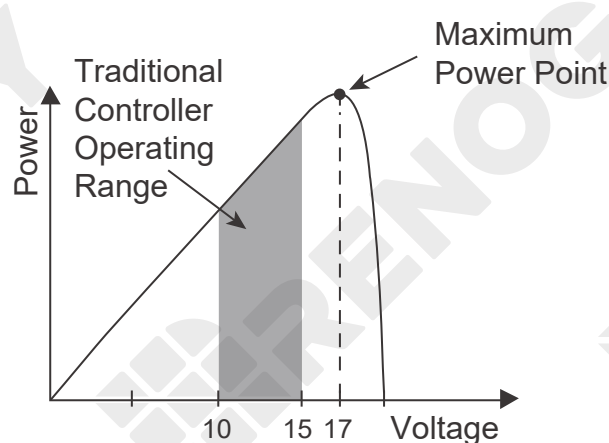

### ■ Limiting Effectiveness

High temperature is the natural enemy of solar panels. With the increase of ambient temperature, the operating voltage ( $V_{mp}$ ) of the solar panel decreases, which limits the power generation of the solar panel. The charge controller encounters an inevitably decrease in charging performance even with the MPPT technology. In this case, it is better to use solar panels with higher nominal voltage, so that the battery can still get current boost even if the voltage drops proportionally.

# Charging and Activation Logic

## Four Charging Stages

Rover Li Series MPPT Solar Charge Controller has a four-stage battery charging algorithm for a rapid, efficient, and safe battery charging. The stages include: Bulk Charging, Boost Charging, Float Charging, and Equalization.

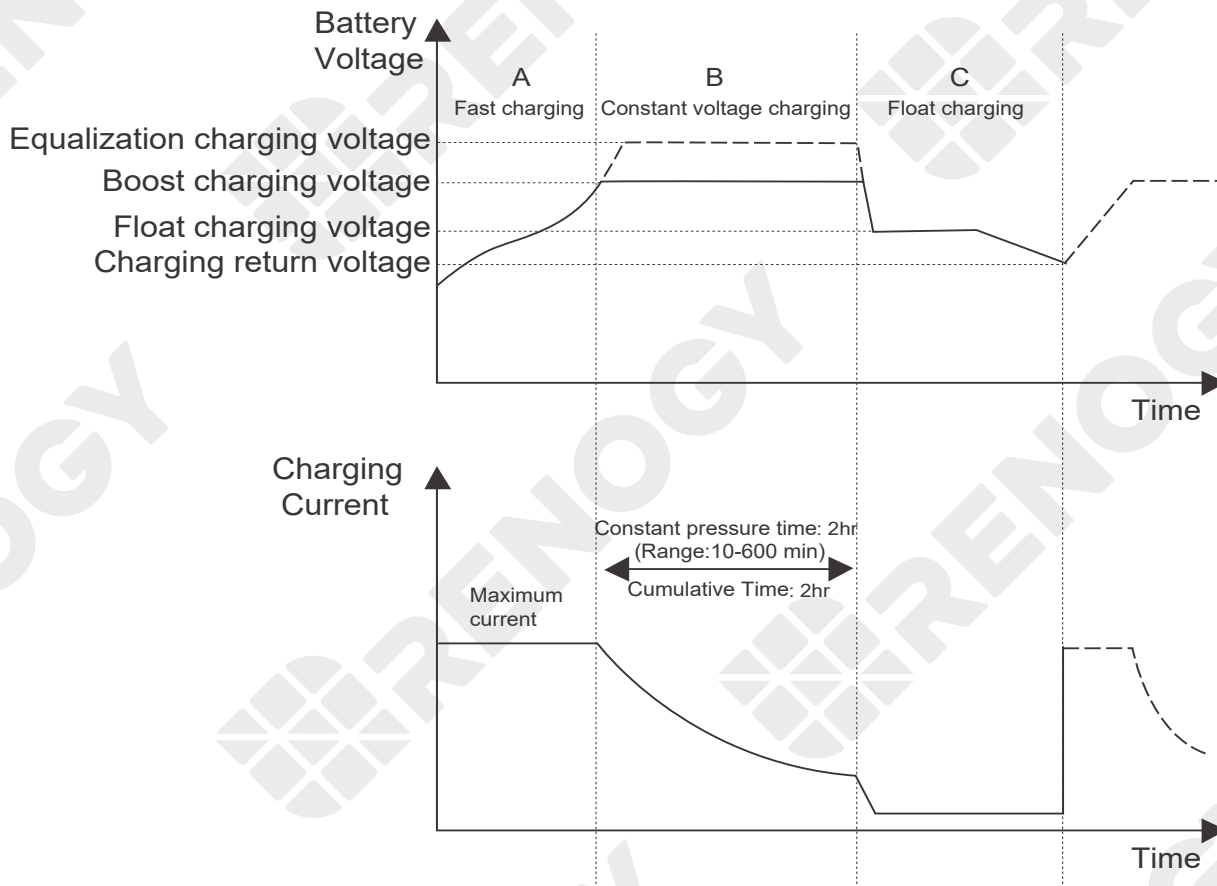

### ■ Bulk Charging:

This algorithm is used for day to day charging. It uses 100% of available solar power to recharge the battery and is equivalent to constant current. In this stage the battery voltage has not yet reached constant voltage (equalization or boost), the charge controller operates in constant current mode, delivering its maximum current to the batteries (MPPT Charging).

### ■ Constant Charging:

When the battery reaches the constant voltage set point, the charge controller will start to operate in constant charging mode, where it is no longer MPPT charging. The current will drop gradually. The charge stages (equalization and boost) are not carried out constantly in a full charge process to avoid too much gas precipitation or overheating of the battery.

**Boost Charging:** Boost stage maintains a charge for 2 hours by default. The user can adjust the constant time and preset value of boost per their demand.

### ■ Float Charging:

After the constant voltage stage, the charge controller will reduce the battery voltage to a float voltage set point. Once the battery is fully charged, there will be no more chemical reactions

# Charging and Activation Logic

and all the charge current would turn into heat or gas. Because of this, the charge controller will reduce the voltage charge to smaller quantity, while lightly charging the battery. The purpose for this is to offset the power consumption while maintaining a full battery storage capacity. In the event that a load drawn from the battery exceeds the charge current, the charge controller will no longer be able to maintain the battery to a Float set point and the charge controller will end the float charging stage and refer back to bulk charging.

## ■ Equalization:

Equalization is carried out every 30 days of the month. It is intentional overcharging of the battery for a controlled period of time. The charge controller charges the battery at a level higher than the voltage that it is typically charged to remove sulfate crystals that build up on the plates over time and balance the voltage of each cell. Periodic equalization charging is beneficial to certain types of batteries because it helps ensure the battery capacity and maintain its runtime.



## CAUTION

- It is recommended to use only non-sealed, vented, flooded, and wet cell lead acid batteries in the equalization stage.
- Do not equalize VRLA type AGM, gel, and lithium cell batteries unless permitted by battery manufacturer.



## WARNING

- Once equalization is active in the battery charging, the charge controller will not exit this stage unless there is an insufficient source of charging current from the solar panel. There should be NO load on the batteries when in equalization charging.
- Overcharging and excessive gas precipitation may damage the battery plates and activate material shedding on them. Too high of an equalization charging or too long of one may cause damage. Review the specific requirements of the battery used in the system carefully.
- Equalization may increase battery voltage to a level that damages to sensitive DC loads. Ensure that allowable input voltages of all loads are greater than the set voltage during equalization charging.

# Charging and Activation Logic

## Lithium Battery Activation

The charge controller can activate sleeping lithium batteries in most cases. Lithium batteries need to be activated when the built-in battery protection is breached, which is usually when lithium batteries are overdischarged. To awaken lithium batteries, the controller will provide a constant voltage and after successful activation, can continue charging like normal.

During activation, the LCD will display **ACT**. If **ACT** displays for more than 2 days, it means the charge controller needs to undergo further troubleshooting. Read [Troubleshooting](#) in the user manual.

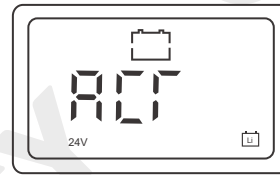

### **i** NOTE

- After connecting the charge controller with the lithium battery, set the battery type and the system voltage. For more instructions, read [Setting the Battery Type](#) and [System Voltage](#) of the user manual.

### ■ Operation Conditions

1. Set the battery type of the charge controller to Li. Set the correct nominal voltage of the lithium battery manually.
2. For 12V lithium batteries, the incoming solar voltage should be greater than or equal to 16V DC and for 24V lithium batteries, the incoming solar voltage should be greater than or equal to 30V DC.

### ■ Working Logic

1. In lithium battery mode, the charge controller automatically enables the activation function and provides a constant voltage of over 13.2V to activate the lithium battery.
2. After the charge controller activates the lithium battery with a constant voltage of 13.2V for 10s, the charge controller will pause for 5s and detect the battery voltage.

If the battery voltage is greater or equal to 11V, the charge controller will exit the lithium battery activation mode.

If the battery voltage is less than 11V, the charge controller will continue to activate the lithium battery.

# Package Contents

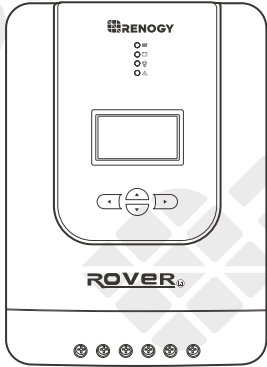
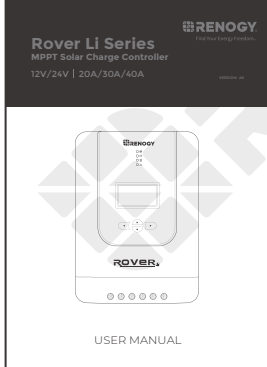
<p>Rover Li Series MPPT Solar Charge Controller × 1</p>	<p>User Manual × 1</p>
 A vertical rectangular solar charge controller with a digital display screen in the center, control buttons below it, and the ROVER logo at the bottom. The top of the device features the RENOGY logo and several status LEDs.	 The cover of the user manual, featuring the product name 'Rover Li Series MPPT Solar Charge Controller' and technical specifications '12V/24V   20A/30A/40A' at the top. The central image shows the front of the charge controller, and the words 'USER MANUAL' are printed at the bottom.

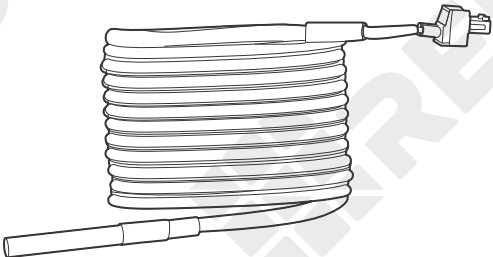
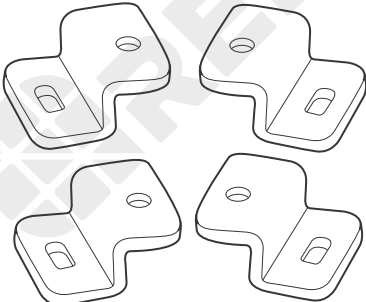
<p>Renogy Temperature Sensor × 1 (Model: RTSCC)</p>	<p>Mounting Bracket × 4</p>
 A temperature sensor cable with a coiled section and a connector at one end, and a thin probe at the other.	 Four L-shaped metal mounting brackets, each with two pre-drilled holes for screws.

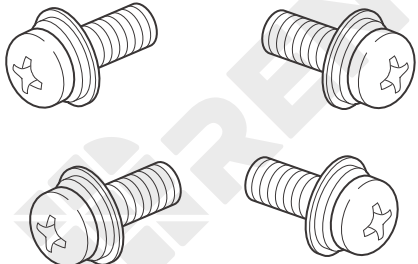
<p>Mounting Bracket Screws × 4</p>
 Four screws with a star-shaped head, used for securing the mounting brackets.

# Optional Accessories

## NOTE

- You can buy the following optional accessories from [renogy.com](https://renogy.com).

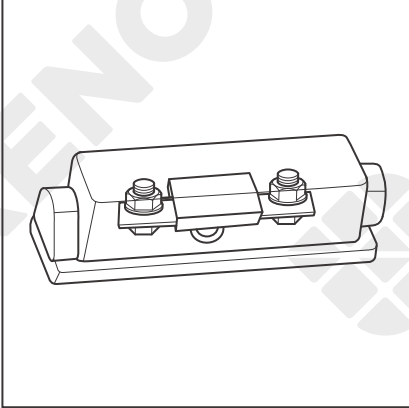

### Battery Fuse

**RNG-CTRL-RVR20: 25A to 30A**

**RNG-CTRL-RVR30: 30A to 40A**

**RNG-CTRL-RVR40: 40A to 50A**

The battery fuse protects the charge controller, cables and batteries from overcurrent.

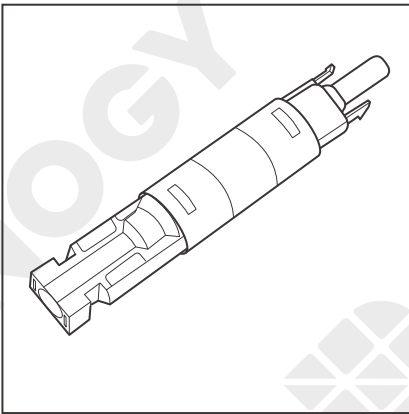

### Solar Panel Fuse

Solar panel fuse provides single circuit protection for solar panels, preventing damage caused by high currents.

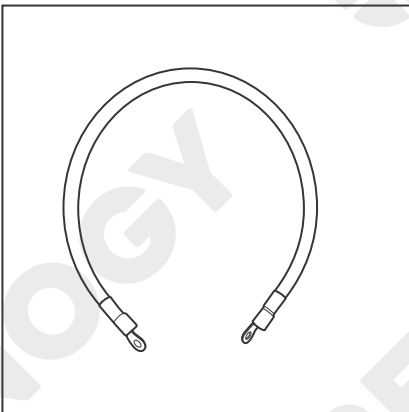

### Fuse Cable

The cable is integrated with copper rings at both ends, enabling the charge controller to be connected with an external fuse.

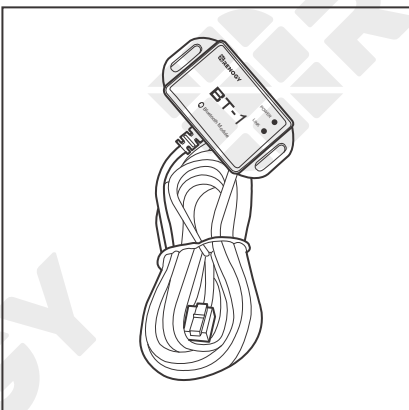

### Renogy BT-1 Bluetooth Module (sold separately)

Pair the Bluetooth Module with Renogy DC Home app to monitor and change parameters through a smartphone or tablet. Download the app by scanning the QR Code on the last page of the user manual.

# Product Overview

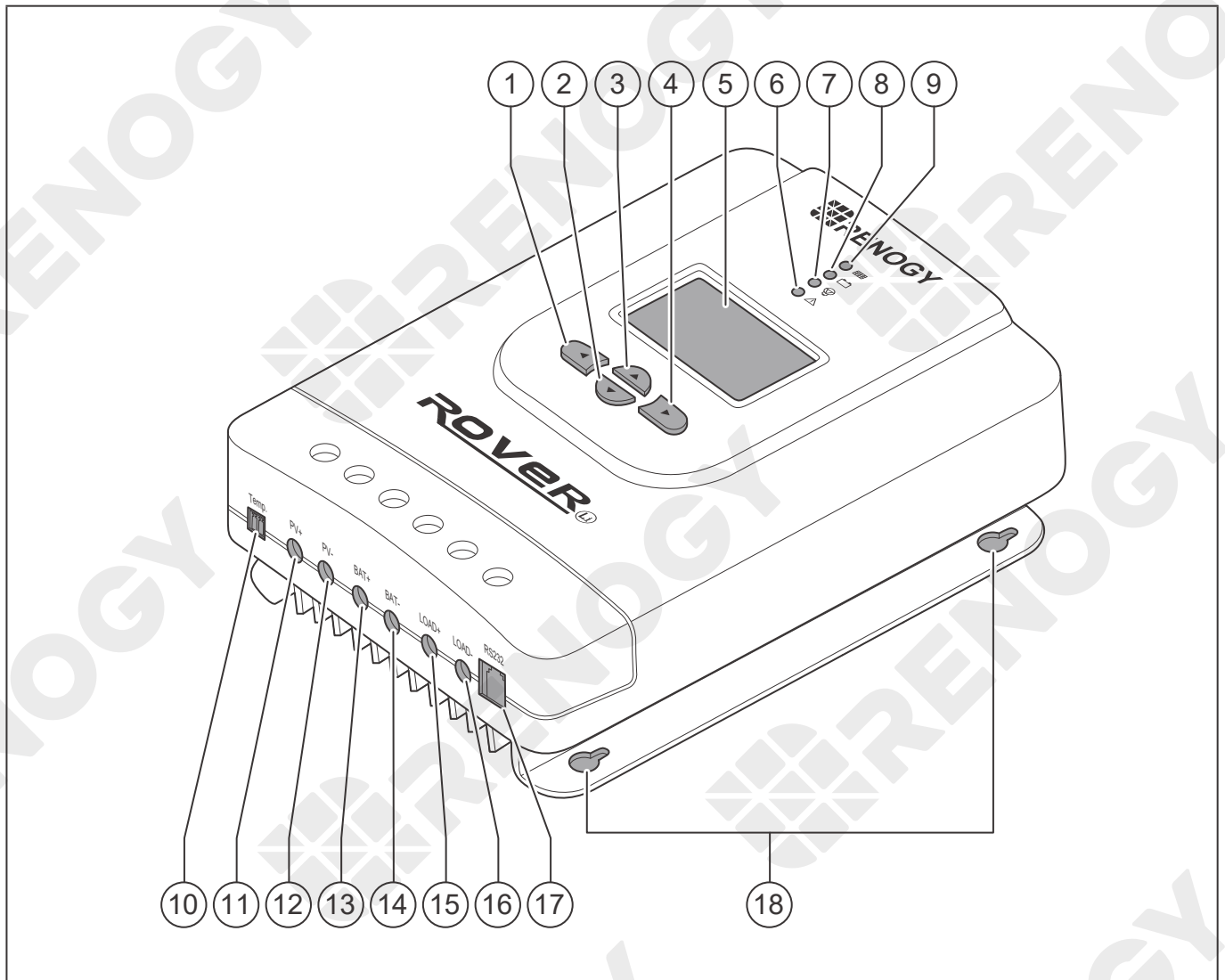

No.	Part & Description	No.	Part & Description
1	Return to the Previous Menu	10	Temperature Sensor Port
2	Page Down / Decrease Parameter Value	11	Positive Solar Terminal (PV+)
3	Page Up / Increase Parameter Value	12	Negative Solar Terminal (PV-)
4	Enter Sub Menu / Save Parameter Value / Turn Load On or Off in Manual Mode	13	Positive Battery Terminal (BAT+)
5	LCD	14	Negative Battery Terminal (BAT-)
6	System Error LED Indicator	15	Positive DC Load Terminal (LOAD+)
7	Load LED Indicator	16	Negative DC Load Terminal (LOAD-)
8	Battery LED Indicator	17	RS232 Port (optional)
9	Solar LED Indicator	18	Mounting Holes



# Wiring Diagram

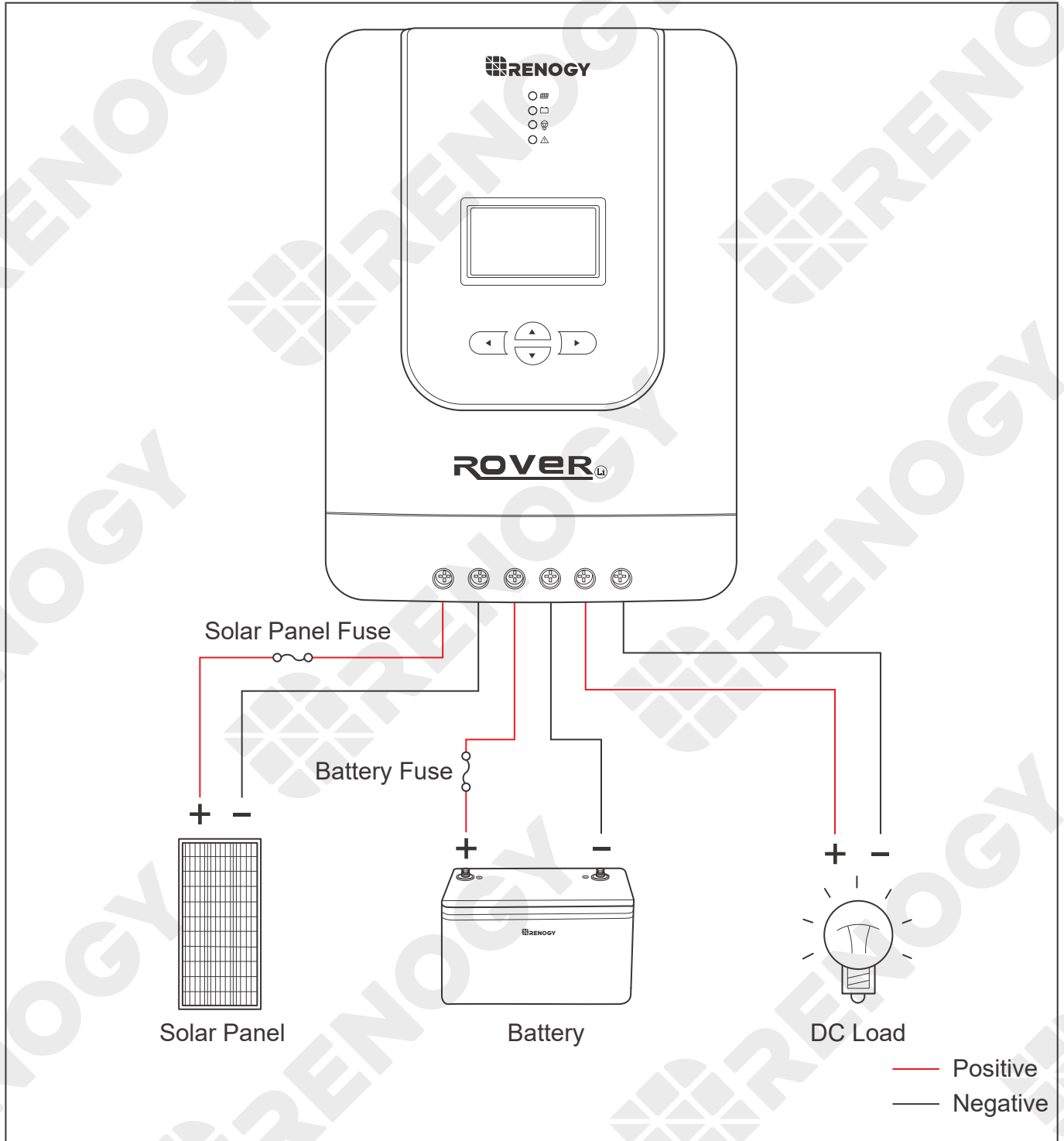



# Recommended Cable and Fuse Sizing

Recommended Cable Sizing

Recommended Fuse Sizing

## Recommended Cable Sizing

Model	Rated Current	Cable	Cable Length (ft) / (m)	Recommended Cable Size
Rover Li 12V/24V 20A MPPT Solar Charge Controller (RNG-CTRL-RVR 20)	20A	Solar (input)	0-10 ft (0-3 m)	12 AWG
			11-20 ft (3-6 m)	10 AWG
			21-30 ft (6-9 m)	8 AWG
		Battery (output)	0-10 ft (0-3 m)	12 AWG
			11-20 ft (3-6 m)	10 AWG
			21-30 ft (6-9 m)	8 AWG
Rover Li 12V/24V 30A MPPT Solar Charge Controller (RNG-CTRL-RVR 30)	30A	Solar (input)	0-10 ft (0-3 m)	10 AWG
			11-20 ft (3-6 m)	8 AWG to 10 AWG
			21-30 ft (6-9 m)	8 AWG
		Battery (output)	0-10 ft (0-3 m)	10 AWG
			11-20 ft (3-6 m)	8 AWG to 10 AWG
			21-30 ft (6-9 m)	8 AWG
Rover Li 12V/24V 40A MPPT Solar Charge Controller (RNG-CTRL-RVR 40)	40A	Solar (input)	0-10 ft (0-3 m)	8 AWG
			11-20 ft (3-6 m)	6 AWG to 8 AWG
			21-30 ft (6-9 m)	6 AWG
		Battery (output)	0-10 ft (0-3 m)	8 AWG
			11-20 ft (3-6 m)	6 AWG to 8 AWG
			21-30 ft (6-9 m)	6 AWG

### NOTE

- The cable specifications listed above account for critical, less than 3% voltage drop and may not account for all configurations.
- The size of the fuse cable is consistent with that of the corresponding cable connecting to the output terminal of the charge controller.

# Recommended Cable and Fuse Sizing

## Recommended Fuse Sizing

For your safety, it is recommended to install fuses at both the input and output ends of the charge controller to ensure safe operations.

### NOTE

- Choose appropriate fuses according to the specifications of the solar panel and the charge controller.

Fuse from Solar Panel to Charge Controller	
Max. Current of Solar Panel to Solar Controller Fuse = Total Amps of Solar Panel (Array) * 1.56	
Solar Panels in Series	Solar Panels in Parallel
Total Amps I: $I_1=I_2=I_3$ Fuse = $I_1 * 1.56$	Total Amps I: $I_1+I_2+I_3$ Fuse = $(I_1+I_2+I_3) * 1.56$

### NOTE

- In the formula, I represents the maximum output current of the solar panel, and 1, 2 or 3 represents the solar panel number, respectively.

### INFO



- Read the user manual of the solar panel to obtain working voltage parameters, and calculate the corresponding fuse current according to the formula.

# Components & Tools

## **i** NOTE

- The adapter cable used in this manual can be made by yourself or purchased from [renogy.com](http://renogy.com) according to the names in Recommended Components.

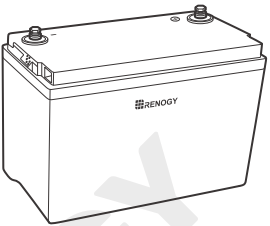
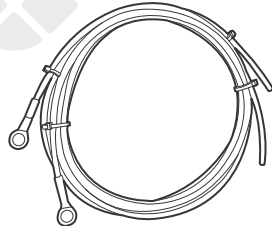
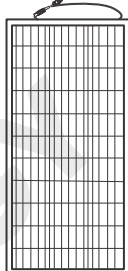
### Recommended Components

Battery	Battery Adapter Cable (Ring Terminal Adapter Cable)	Solar Panel	Solar Panel Extension Cables
			

### Required Tools

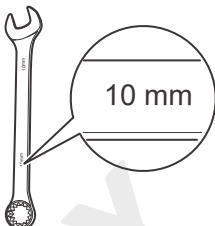
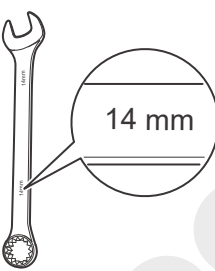
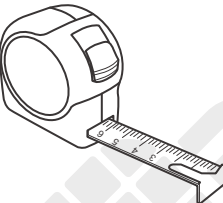
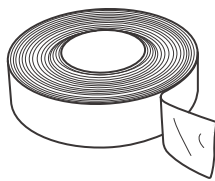
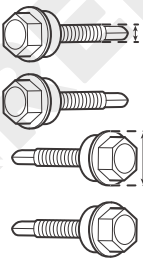
Phillips Screwdriver (#2)	Wrench (10 mm)	Wrench (14 mm)
		
Measuring Tape	Insulation Tape	Self-tapping Bolts
		 <ul style="list-style-type: none"> <li>RVR-20: ≤5.2 mm</li> <li>RVR-20: ≤0.2 inch</li> <li>RVR-30/40: ≤4.5 mm</li> <li>RVR-30/40: ≤0.17 inch</li> <li>RVR-20: ≤9 mm</li> <li>RVR-20: ≤0.35 inch</li> <li>RVR-30/40: ≤10 mm</li> <li>RVR-30/40: ≤0.39 inch</li> </ul>

# Preparation

Inspection

Environment

Placement

Checking Battery

Checking Solar Panel

## Inspection

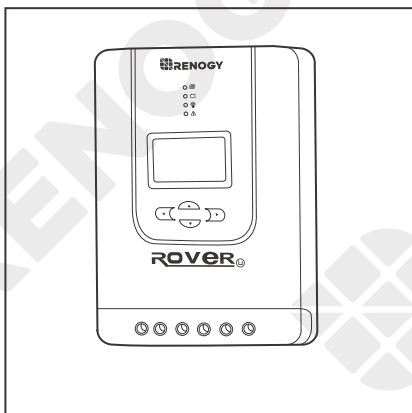

1. Inspect the charge controller for any visible damage including cracks, dents, deformation, and other visible abnormalities. All connector contacts shall be clean, dry, and free of dirt and corrosion.



### WARNING

- Do not use the charge controller if it has any visible damage.

## Environment

Install the charge controller indoors and prevent its components from being exposed to direct sunlight. Prevent water from entering the charge controller. Make sure there is good ventilation.

Make sure that the charge controller is installed with ambient temperature range from  $-4^{\circ}\text{F}$  to  $140^{\circ}\text{F}$  or  $-20^{\circ}\text{C}$  to  $60^{\circ}\text{C}$ . To ensure optimal working efficiency, it is recommended to keep the ambient temperature range from  $-4^{\circ}\text{F}$  to  $113^{\circ}\text{F}$  or  $-20^{\circ}\text{C}$  to  $45^{\circ}\text{C}$ . Make sure that the charge controller is installed in an environment with relative humidity between 0% and 95% and no condensation.



### NOTE

- Install the charge controller as close to the battery as possible to avoid voltage drops due to long cables.



### WARNING

- Risk of explosion! Never install the charge controller in a sealed enclosure with flooded batteries!

# Preparation

Inspection

Environment

**Placement**

Checking Battery

Checking Solar Panel

## Placement

The charge controller can be fixed vertically (terminals facing down) to a wall or horizontally to the floor.

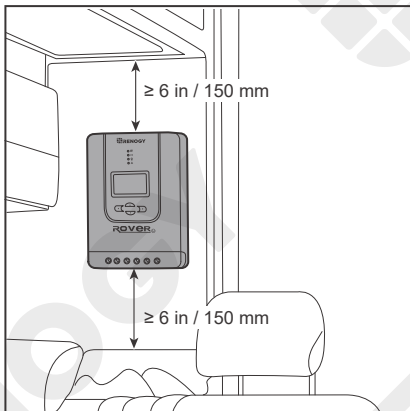
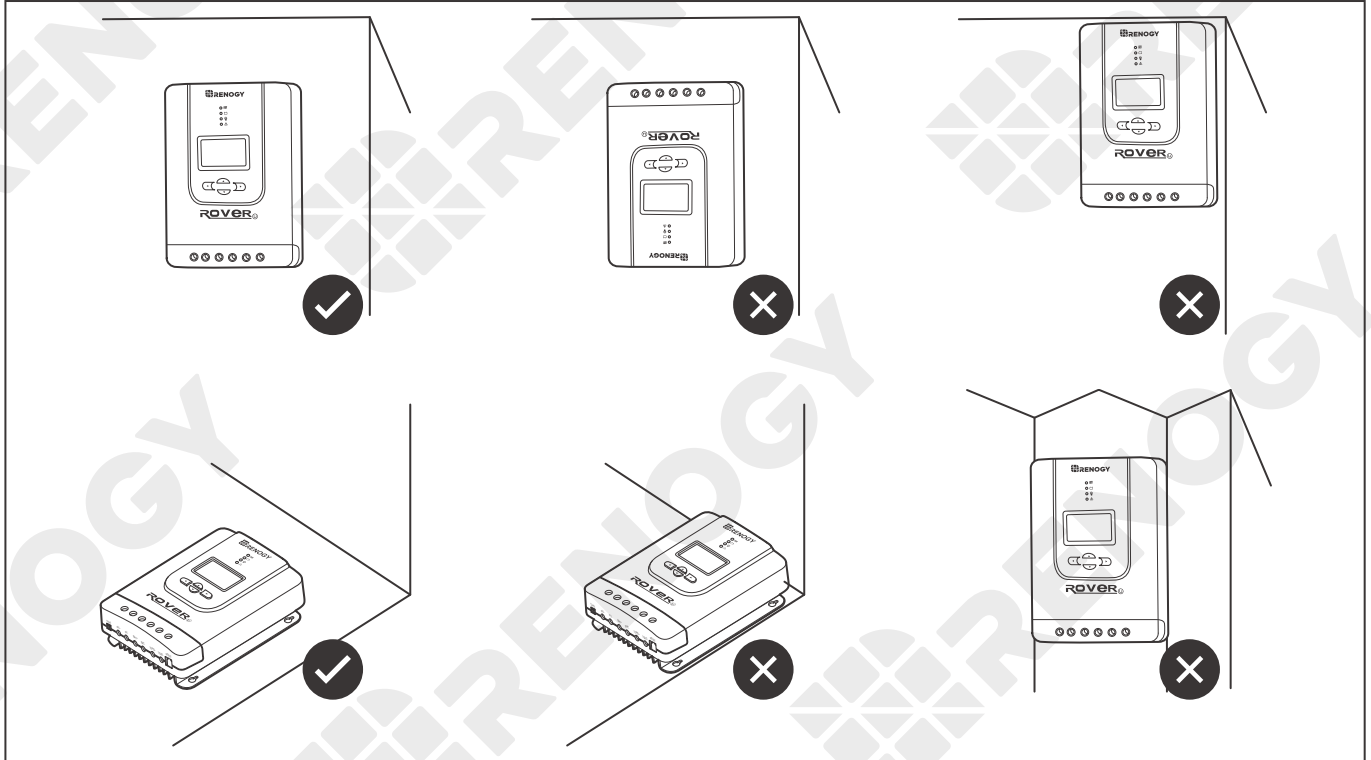

1. Ensure that there is enough space to install the cable. The charge controller requires at least 6 inches (150 mm) of clearance above and below for proper air flow. Ventilation is highly recommended if it is mounted in an enclosure.

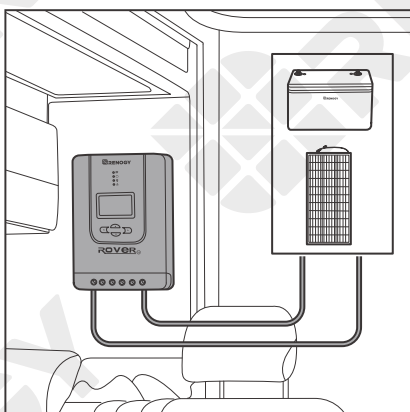

2. Measure the length of the cables connecting to the battery and the solar panel to make sure that they can be connected to the charge controller.

# Preparation

Inspection

Environment

Placement

Checking Battery

Checking Solar Panel

## NOTE

- If the Battery Adapter Cable or Solar Panel Extension Cable is not long enough, you can use more extension cables or reselect the installation site.
- Read the [Recommended Cable and Fuse Sizing](#) in this manual, and select appropriate cables according to the usage.

## Checking Battery

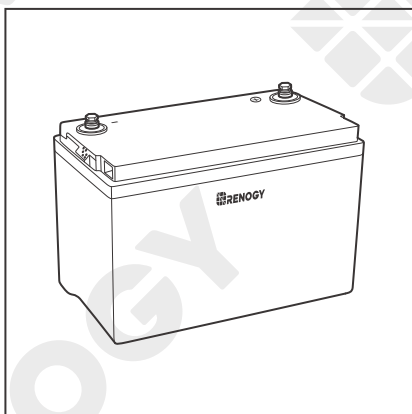

1. Inspect the battery for any visible damage including cracks, dents, deformation, and other visible abnormalities. All connector contacts shall be clean, dry, and free of dirt and corrosion.

## INFO

- Read the user manual of the battery carefully before installation.

## NOTE

- Make sure the battery is working normally.
- The charge controller can only be applied to deep-cycle gel, flooded, SLD, AGM and Li batteries.
- Be sure to wear protective goggles. If getting electrolyte in your eyes, flush your eyes with clean water immediately.

## CAUTION

- Do not dispose of batteries as household waste. Comply with local, state, and federal laws and regulations and use recycling channels as required.

## WARNING

- Do not use the battery if it has any visible damage.
- Do not touch the exposed electrolyte or powder if the battery housing is damaged.
- The battery may produce explosive gases when being charged. Make sure there is good ventilation.

# Preparation

Inspection

Environment

Placement

Checking Battery

Checking Solar Panel

System Voltage	
Battery or Battery Pack System Voltage = System Voltage U	
Batteries in Series	Batteries in Parallel
System Voltage U: $U_1+U_2+U_3$	System Voltage U: $U_1=U_2=U_3$

2. Combine the batteries in parallel or series as needed. This charge controller supports a maximum system voltage of 32V. Read the user manual for battery voltage parameters, and calculate the voltage of the battery or battery pack system according to the formula to ensure that it does not exceed 32V.

## NOTE

- In the formula, U represents the battery voltage, and 1, 2 or 3 represents the battery number respectively.

## WARNING

- Do not use the charge controller if the battery or battery pack system voltage exceeds 32V. Doing so will cause damage to the charge controller.

## Checking Solar Panel

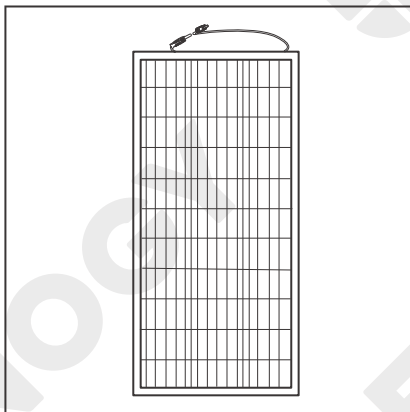

1. Inspect the solar panel for any visible damage including cracks, dents, deformation, and other visible abnormalities. All connector contacts shall be clean, dry, and free of dirt and corrosion.

## INFO

- Read the user manual of the solar panel carefully before installation.

## NOTE

- The solar panels can be combined in parallel or in series as needed.
- Identify the polarities (positive and negative) on the cables used for solar panels. A reverse polarity contact may damage the charge controller.

# Preparation

 **WARNING**

- Do not use the solar panel if it has any visible damage.

Maximum Output Power	
Maximum Output Power of Solar Panel or Solar Panel Array = Maximum Solar Input Power W	
Solar Panels in Series	Solar Panels in Parallel
Maximum Output Power W: $W_1+W_2+W_3$	Maximum Output Power W: $W_1+W_2+W_3$

- Read the user manual of the solar panel, and calculate the maximum output power of the solar panel or the solar panel array according to the formula.

 **NOTE**

- In the formula, W represents the maximum output power of the solar panel, and 1, 2 or 3 represents the solar panel number, respectively.

Model	RNG-CTRL-RVR 20	RNG-CTRL-RVR 30	RNG-CTRL-RVR 40
Rated Solar Input Power	12V @ $\leq 260W$	12V @ $\leq 400W$	12V @ $\leq 520W$
	24V @ $\leq 520W$	24V @ $\leq 800W$	24V @ $\leq 1040W$

Working Voltage	
Working Voltage of Solar Panel or Solar Panel Array = Working voltage U	
Solar Panels in Series	Solar Panels in Parallel
Working Voltage U: $U_1+U_2+U_3$	Working Voltage U: $U_1=U_2=U_3$

- Read the user manual of the solar panel, and calculate the working voltage of the solar panel or the solar panel array according to the formula.

 **NOTE**

- In the formula, U represents the working voltage of the solar panel, and 1, 2 or 3 represents the solar panel number, respectively.

 **WARNING**

- Ensure that the working voltage of the solar panel or the solar panel array does not exceed 100V.



# Mounting

Wall-mounted

Mounting with Brackets



The charge controller can be mounted on a vertical surface with mounting holes or provided brackets.

## NOTE

- Make sure that the charge controller is installed firmly to prevent it from falling off.

### Wall-mounted

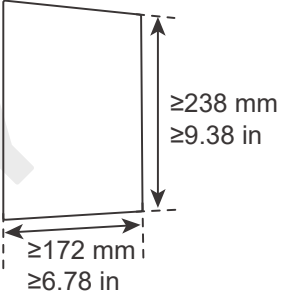
#### Required Tools

Installation Template (Letter Size)	Marker Pen
	

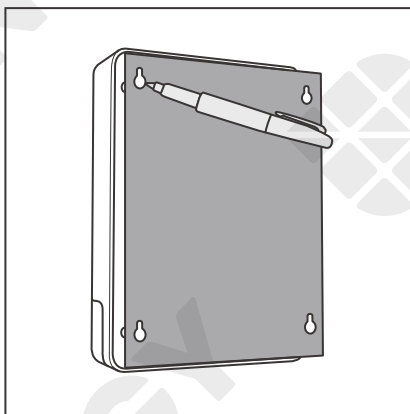

1. Mark the four mounting holes on a piece of paper.

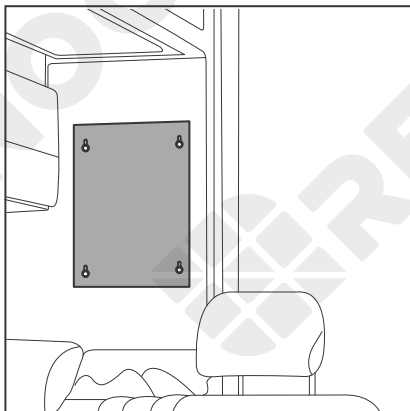

2. Tape the paper to the desired location for installation.

# Mounting

Wall-mounted

Mounting with Brackets

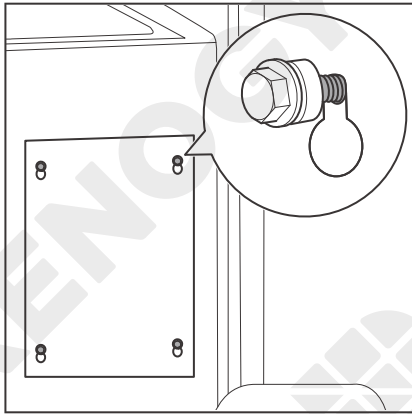

3. Install the screws according to the mounting holes marked on the paper. Do not overtighten the bolt.

## **i** NOTE

- Choose appropriate screws according to the mounting holes of the charge controller, and leave some gap between the screw and the surface.

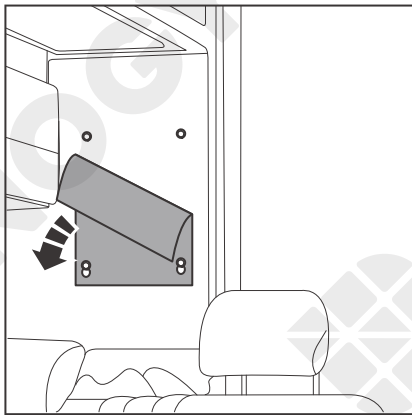

4. Tear off the paper.

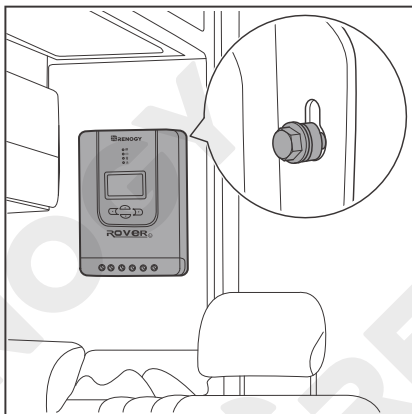

5. Hang the charge controller onto the wall and verify all screw heads are in the mounting holes.

# Mounting

## Wall-mounted

## Mounting with Brackets

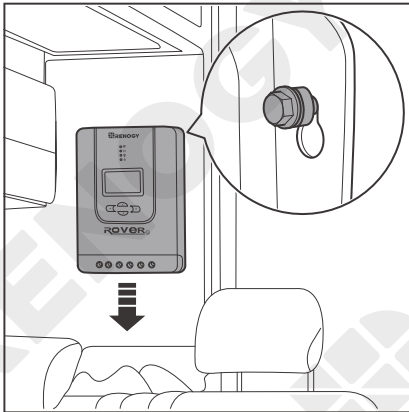

6. Release the charge controller and slide it down into place. Tighten the screws.

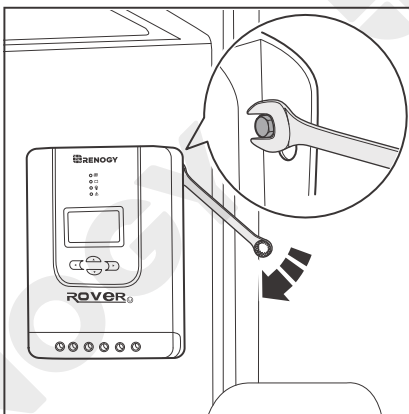

7. If the screws are not secure, tighten them clockwise with a suitable wrench.

### **i** NOTE

- If the gap between the charge controller and the mounting surface is too large and the screws cannot be tightened with a wrench, remove the charge controller and adjust the screws. Ensure that there is no gap between the charge controller and the surface.

## Mounting with Brackets

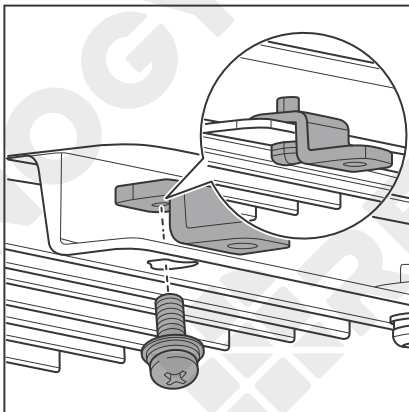

1. Secure the Mounting Brackets on the mounting holes of the charge controller with the Mounting Bracket Screws.

# Mounting

Wall-mounted

Mounting with Brackets

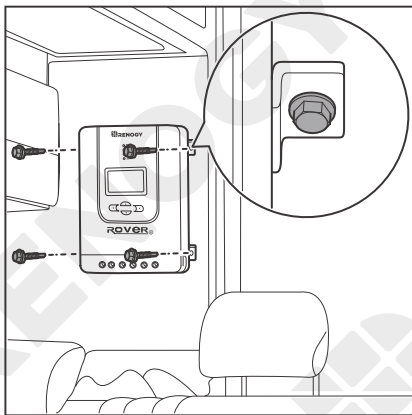

2. Place the charge controller against a flat surface and secure it with screws.

## **i** NOTE

- Choose appropriate screws according to the mounting holes of the charge controller.

# Installation

Battery Wiring

Solar Wiring

Load Wiring (Optional)

## Battery Wiring

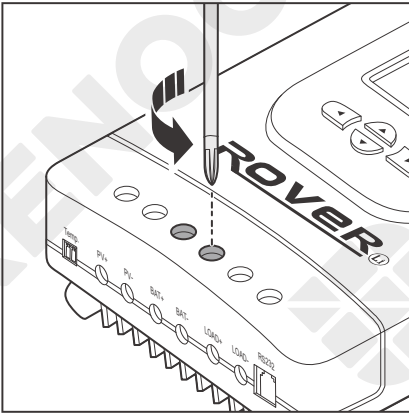

1. Rotate the cable retainer of the BAT-, and BAT+ terminals counterclockwise with a screwdriver.

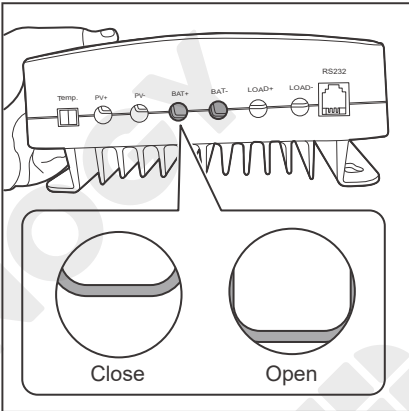

2. Make sure the cable retainer is completely open.

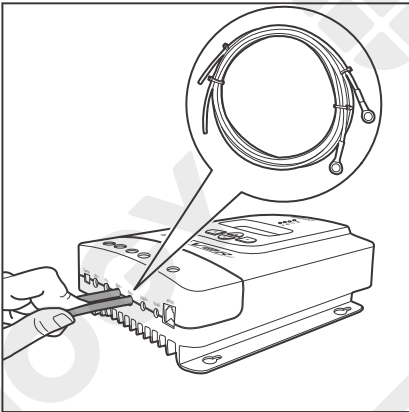

3. Insert the bare ends of the Battery Adapter Cables into the corresponding BAT+ and BAT-.

### NOTE

- Strip off some of the protective sheath of cables and insert the bare ends of the cables into the screw terminals.

# Installation

Battery Wiring

Solar Wiring

Load Wiring (Optional)

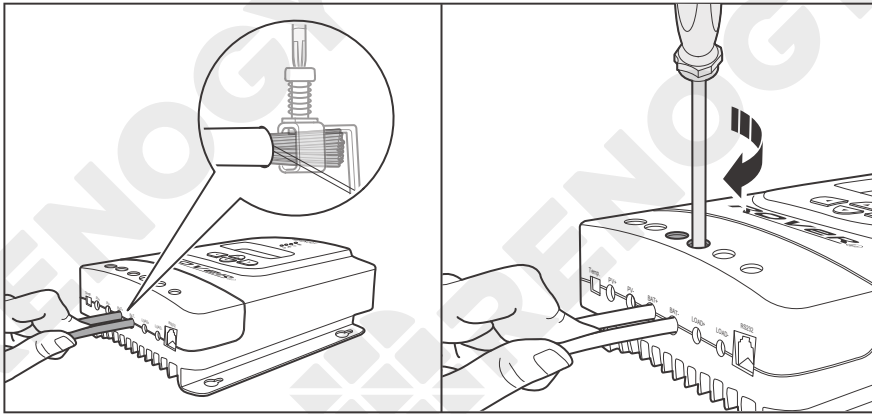

4. Rotate the screws clockwise to clamp the wire down and close the cable retainer.

## **i** NOTE

- The torque of the cable retainer is 1.2 N·m (10.53 lb-inch). Do not overtighten the cable retainer screws. Otherwise it will lead to stripped screws or screw bending.

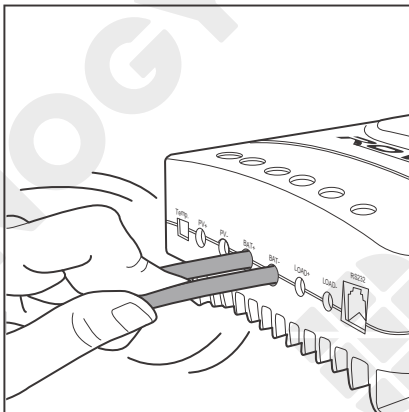

5. Make sure all connections are tight and secure.

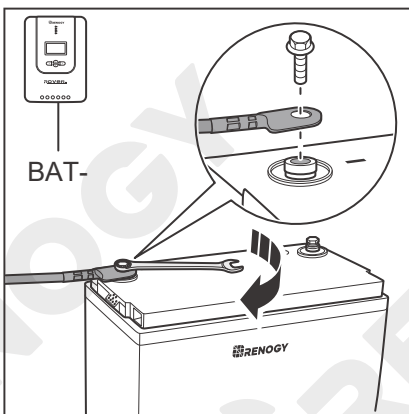

6. Attach the Battery Adapter Cable connecting to the BAT- of the charge controller to the negative terminal of the battery, and tighten the bolt with a wrench.

## **i** NOTE

- Select a suitable wrench according to the specifications of the positive and negative wire fixing bolts of the battery.
- Make sure all connections are tight and secure.

## **!** WARNING

- Identify the polarities (positive and negative) on the cables used for the batteries. A reverse polarity contact may damage the charge controller.

# Installation

Battery Wiring

Solar Wiring

Load Wiring (Optional)

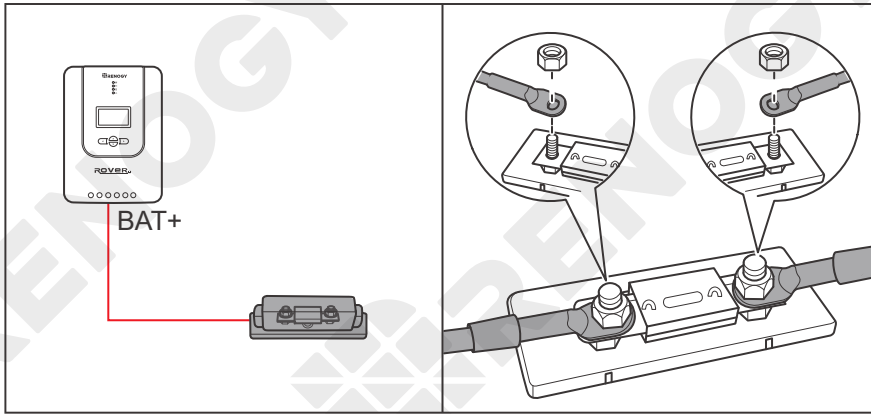

7. For your safety, it is recommended to use a battery fuse. Connect the Battery Adapter Cable connecting to the BAT+ to one end of the battery fuse, and then connect the other end to the fuse cable.

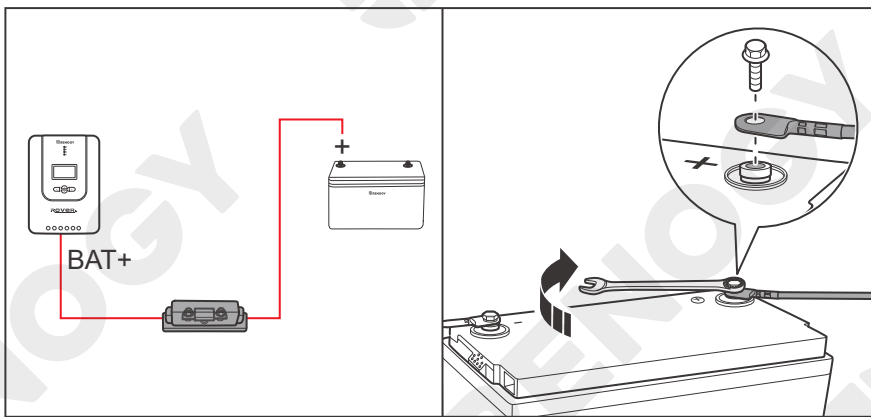

8. Attach the Battery Adapter Cable connecting to the BAT+ of the charge controller to the positive terminal of the battery, and tighten the bolt with a wrench.

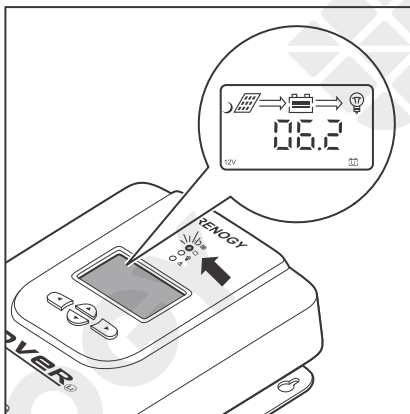

9. Once the tray cables are connected to the battery, the LCD and the Battery LED Indicator will light up, and the charge controller enters nighttime mode.

# Installation

Battery Wiring

Solar Wiring

Load Wiring (Optional)

## Solar Wiring

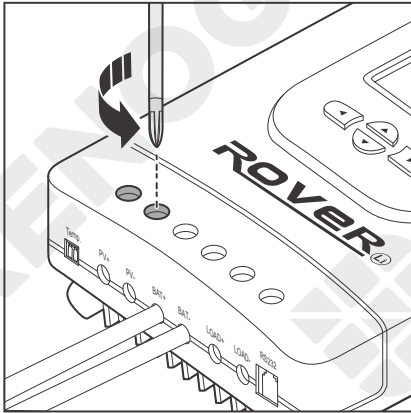

1. Rotate the cable retainer of the PV-, and PV+ terminals counterclockwise with a screwdriver.

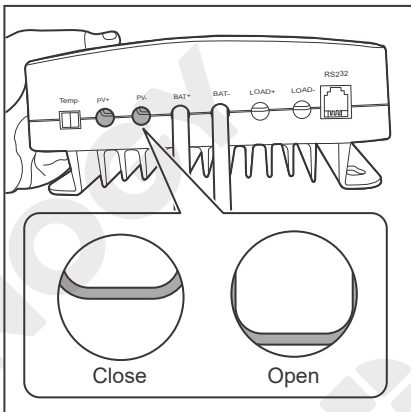

2. Make sure the terminal hatch is completely open.

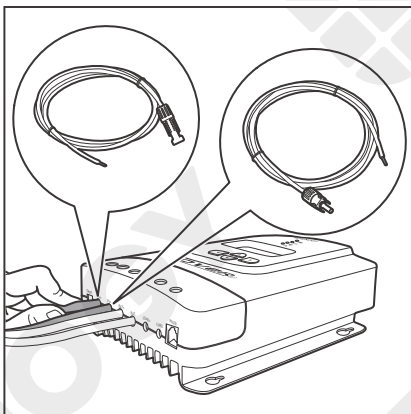

3. Insert the bare ends of the Solar Panel Extension Cables into the corresponding PV+ and PV-.

### **i** NOTE

- Strip off some of the protective sheath of cables and insert the bare ends of the cables into the screw terminals.
- Connect the male connector of the Solar Panel Extension Cable to the PV- and the female connector to the PV+.



# Installation

Battery Wiring

Solar Wiring

Load Wiring (Optional)

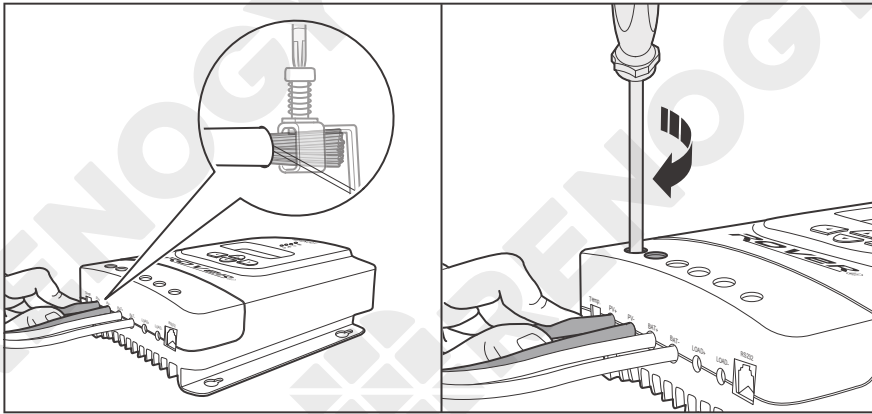

4. Rotate the screws clockwise to clamp the wire down and close the cable retainer.

## **i** NOTE

- The torque of the cable retainer is 1.2 N·m (10.53 lb-inch). Do not overtighten the cable retainer screws. Otherwise it will lead to stripped screws or screw bending.

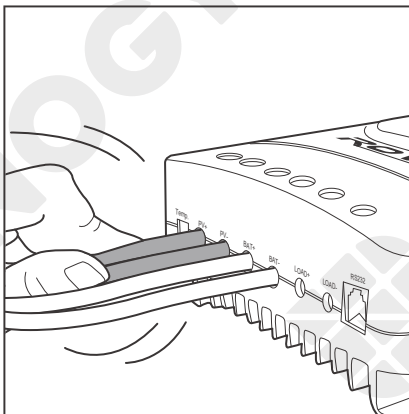

5. Make sure all connections are tight and secure.

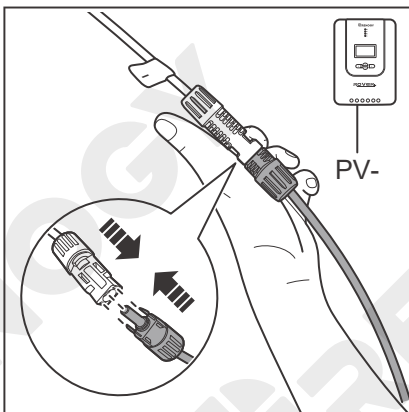

6. Connect the Solar Panel Extension Cable connecting to PV- of the charge controller to the negative terminal of the solar panel.

## **i** NOTE

- Make sure all connections are tight and secure.

# Installation

Battery Wiring

Solar Wiring

Load Wiring (Optional)

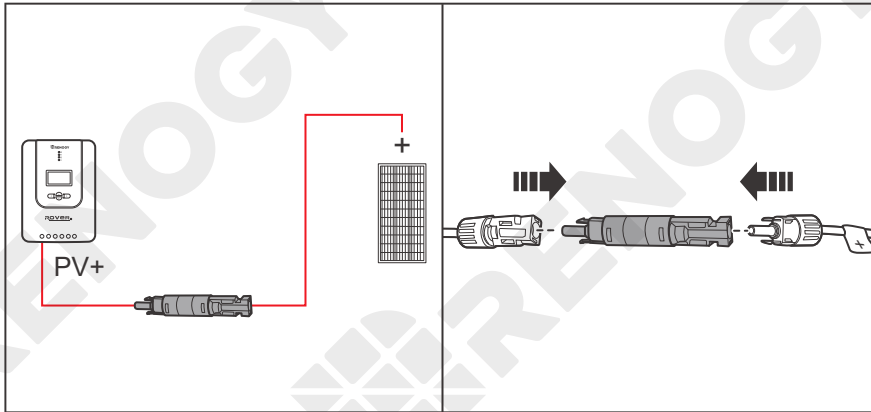

7. For your safety, it is recommended to use a battery fuse and a solar panel fuse. Connect the Solar Panel Extension Cable connecting to the PV+ to one end of the solar panel fuse, and then connect the other end of the fuse to the positive terminal of the solar panel.

## **i** NOTE

- Read the [Recommended Cable and Fuse Sizing](#) in this manual, and select appropriate solar panel fuses according to the usage.
- Remove the cover of the solar panels or place them face up after connection.

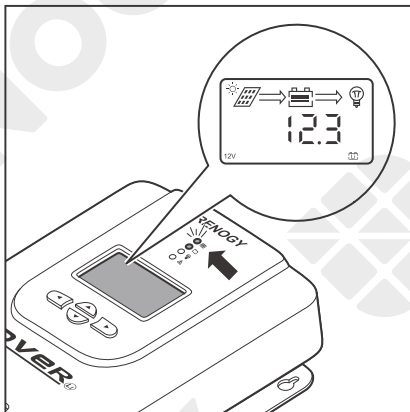

8. Once the Solar Panel Extension Cables are connected to the solar panels, the Solar LED Indicator will light up, and the charge controller enters daytime mode.

The charge controller needs troubleshooting if any of the following errors occur:

- The LCD does not light up.
- The battery voltage is not displayed on the LCD.
- The Battery LED Indicator or the Solar LED Indicator does not light up.

Read [Troubleshooting](#) in the user manual. For more instructions, contact our customer service through [renogy.com/contact-us/](https://renogy.com/contact-us/).

## Load Wiring (Optional)

You can choose to connect the charge controller to a DC load ( $\leq 20A$ ) on demand.

### Recommended Accessories

Bare Wire

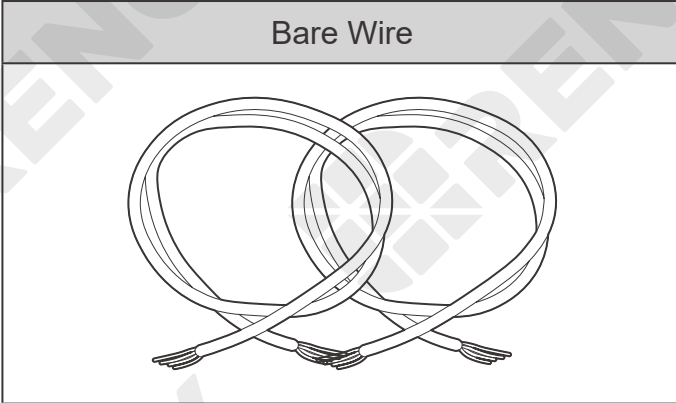

### NOTE

- DC load operating current needs to be less than or equal to 20A.
- Select appropriate cables based on the DC load operating current.
- The DC load is powered by batteries, so ensure that the DC load is compatible with the battery voltage. If a 12V DC load is installed in a 24V battery system, the incorrect connection will damage the charge controller and void the warranty.

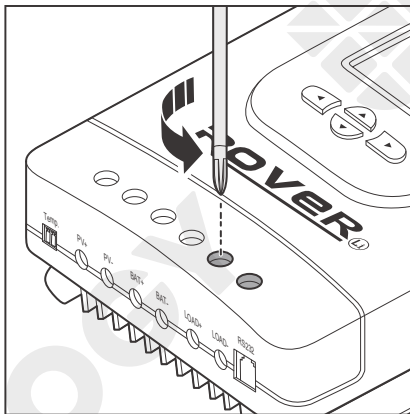

1. Rotate the cable retainer of the LOAD-, and LOAD+ terminals counterclockwise with a screwdriver.

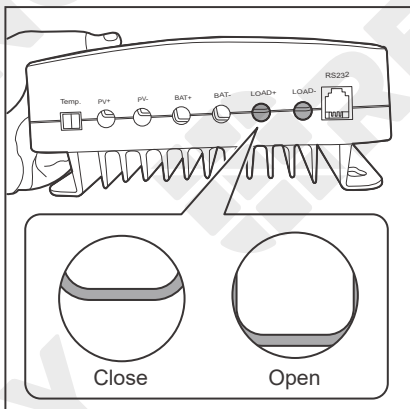

2. Make sure the cable retainer is completely open.

# Installation

Battery Wiring

Solar Wiring

Load Wiring (Optional)

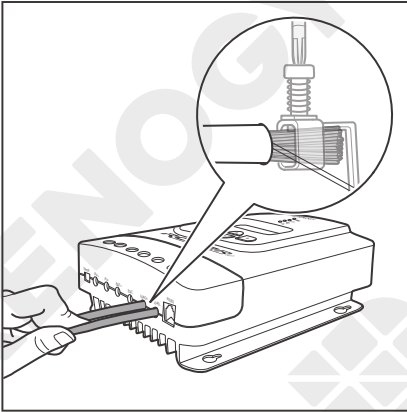

3. Insert the bare ends of the cables into both LOAD- and LOAD+ terminals.

## **i** NOTE

- Strip some insulation off bare wires according to the depth of the installation hole.

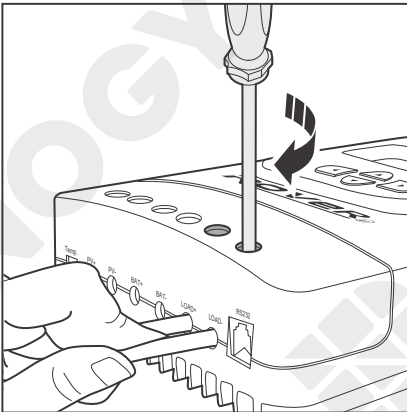

4. Rotate the screws clockwise to clamp the wire down and close the cable retainer.

## **i** NOTE

- The torque of the cable retainer is 1.2 N·m (10.53 lb-inch). Do not overtighten the cable retainer screws. Otherwise it will lead to stripped screws or screw bending.

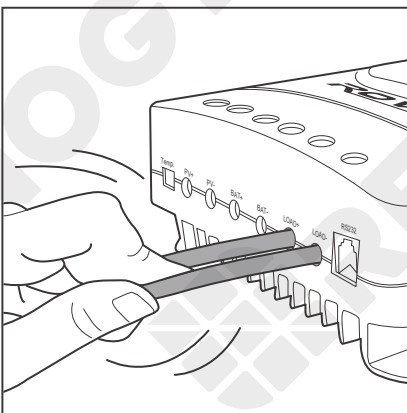

5. Make sure all connections are tight and secure.

# Installation

Battery Wiring

Solar Wiring

Load Wiring (Optional)

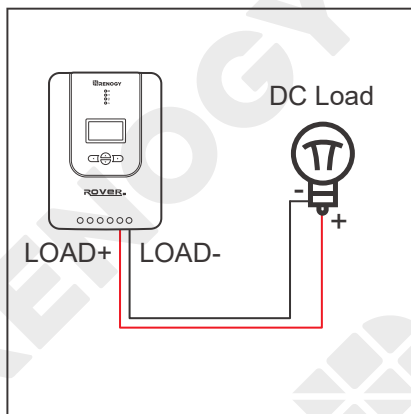

6. Connect the cable at the LOAD- terminal to the negative terminal of the load and connect the cable at the LOAD+ terminal to the positive terminal of the load.

# Temperature Sensor

The temperature sensor can detect the temperature of the battery and send the temperature to the charge controller for charging voltage calibration, ensuring that the charge controller (with operating temperature ranging from  $-35^{\circ}\text{C}$  to  $45^{\circ}\text{C}$  or  $-31^{\circ}\text{F}$  to  $113^{\circ}\text{F}$ ) can charge the battery normally.



## CAUTION

- Do not use the temperature sensor on a LiFePO<sub>4</sub> (LFP) battery which comes with a battery management system (BMS).

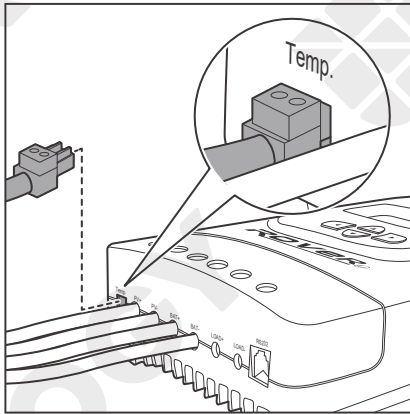

1. Insert the green connector of the Temperature Sensor to the Temperature Sensor Port of the charge controller.

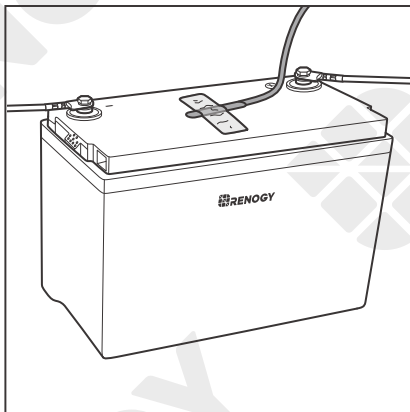

2. Adhere the sensor on the top or side of the battery with the insulation tape.

# Bluetooth Module (Optional)

With a Renogy BT-1 Bluetooth Module, the charge controller can be connected to the DC Home app for remote device monitoring. You can monitor and modify parameters of the charge controller through the DC Home app.

## INFO

- Read the user manual of the Renogy BT-1 Bluetooth Module carefully before connection.

## NOTE

- Make sure that the charge controller is turned on before the connection.
- Scan the QR code on the last page of the user manual to download the DC Home app.

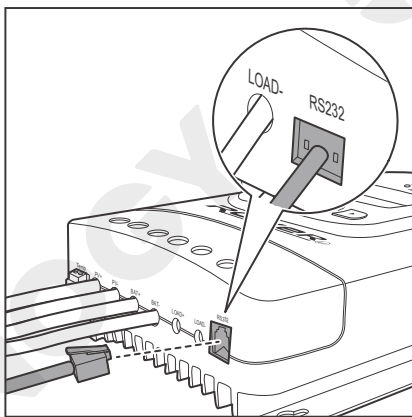

1. Connect the Bluetooth Module to the RS232 port on the charge controller.

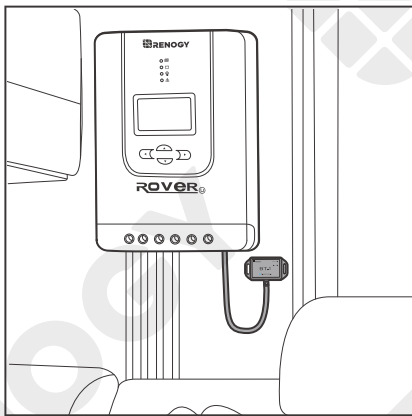

2. Place the Bluetooth module in a suitable site.

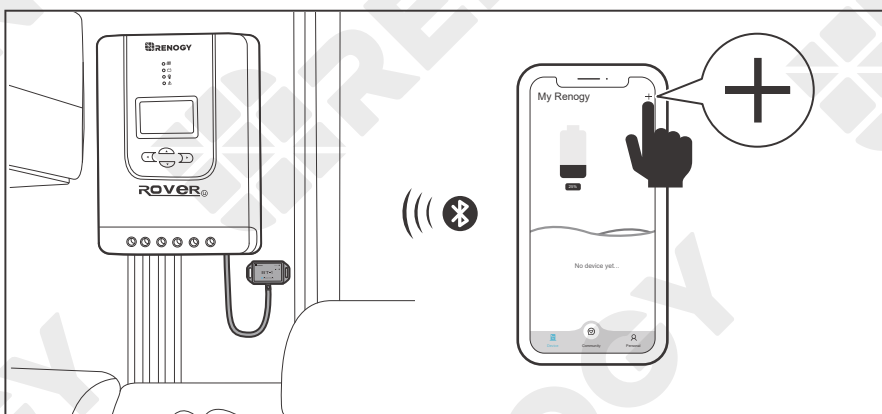

3. Open the DC Home app. Tap + to search for new devices.

# Bluetooth Module (Optional)

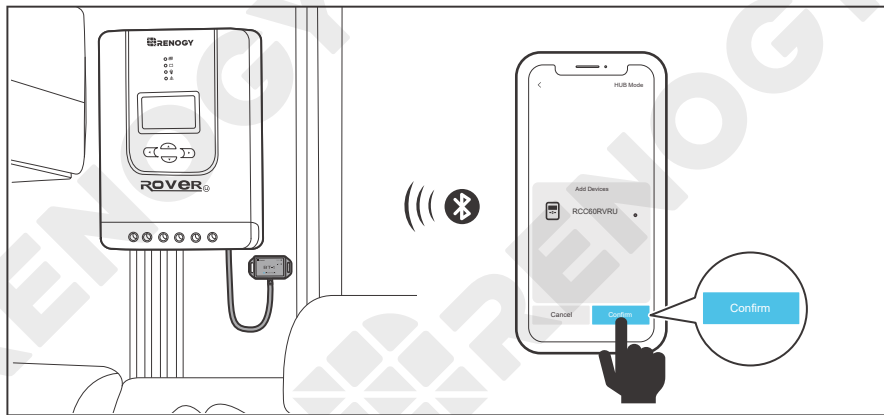

4. Tap **Confirm** to add the newly found charge controller to the device list.



5. Tap the charge controller to check parameters of the charge controller. To modify parameters, see [User Mode](#) in the user manual.



# Battery Type

## Setting the Battery Type

Set the battery type immediately after installing the charge controller. If the charge controller has been connected to a Renogy BT-1 Bluetooth Module, you can also set the battery type from the DC Home app. For more details, see [User Mode](#) in this manual.



### WARNING

- Refer to technical specifications of the battery provided by the manufacturer when choosing a preset battery. Incorrect battery type selection resulting in damage will not be covered by warranty.

### NOTE

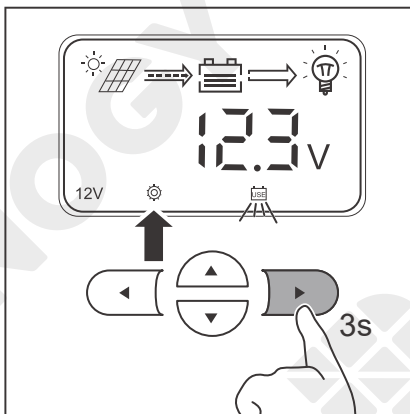
- To cancel the setting and exit, press .



1. Press and hold  on the charge controller for about 3 seconds until  is lit up and the battery type icon starts flashing.

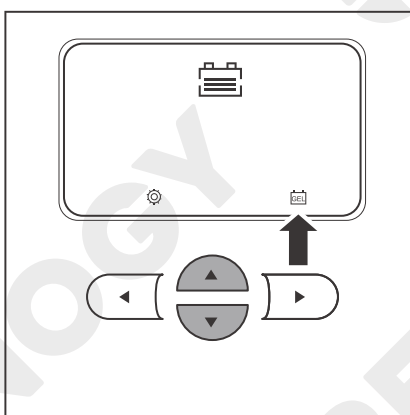

2. Press  or  to select the desired battery type.

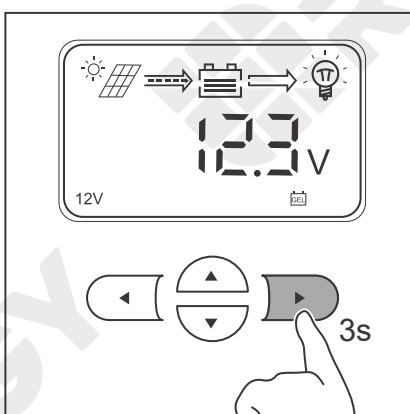

3. After the battery type has been selected, press and hold  for about 3 seconds to save the settings.

# Battery Type

## Battery Charging Parameters

If your battery is not compatible with the preset charging configuration of the charge controller, enter the user mode to program battery parameters. If the charge controller has been connected to a Renogy BT-1 Bluetooth Module, you can also program battery parameters through the DC Home app. For more instructions, read the [User Mode](#) in this manual.



### WARNING

- Before modifying battery parameters, check the table below first. Incorrect parameter setting will damage the charge controller and void the warranty.

Battery Type Parameters	AGM / SLD	Gel	Flooded	Li (LFP)	User Mode	User Recommended
Overvoltage Shutdown	16.0V	16.0V	16.0V	16.0V*	[16.0V]	—
Equalization Voltage	—	14.6V	14.8V	—	14.4V	9.0-17.0V
Boost Voltage	14.2V	14.4V	14.6V	14.4V*	14.4V	9.0-17.0V
Float Voltage	13.8V	13.8V	13.8V	—	14.4V	9.0-17.0V
Boost Return Voltage	13.2V	13.2V	13.2V	13.2V	[13.2V]	—
Undervoltage Warning	12.0V	12.0V	12.0V	12.0V	[12.0V]	—
Undervoltage Return	12.2V	12.2V	12.2V	12.2V	[12.2V]	9.0-17.0V
Low Voltage Disconnect	11.0V	11.0V	11.0V	11.0V	[11.1V]	9.0-17.0V
Low Voltage Reconnect	12.6V	12.6V	12.6V	12.6V	[12.6V]	9.0-17.0V
Equalization Duration	—	2 hours	2 hours	—	[0-300 min]	—
Boost Duration	2 hours	2 hours	2 hours	—	0-300 min	10-300 min



### NOTE

- The parameters listed in the table above apply to 12V batteries. For the 24V batteries, double the number of the parameters.
- Parameters in square brackets ([ ]) are automatically adjusted according to the relevant settings, and cannot be set directly.

# Battery Type

Setting the Battery Type

Battery Charging Parameters

User Mode

- \* By default, Boost Voltage and Overvoltage Shutdown values are set to 14.4V and 16.0V respectively for lithium batteries. Manual modification on Boost Voltage for lithium batteries may trigger Overvoltage Shutdown alarms. Therefore, the Rover Li charge controller automatically sets the Overvoltage Shutdown parameter to a value of Boost Voltage plus 2 to ensure normal battery charging.
- For the default values of User Mode, refer to the DC Home App.

## User Mode

### WARNING

- Before modifying battery parameters in user mode, check the table below and consult the battery manufacturer to check whether modification is allowed. Incorrect parameter setting will damage the charge controller and void the warranty.

Parameters	Description
Model	Rover Li 12V/24V 20A MPPT Solar Charge Controller (RNG-CTRL-RVR20)
	Rover Li 12V/24V 30A MPPT Solar Charge Controller (RNG-CTRL-RVR30)
	Rover Li 12V/24V 40A MPPT Solar Charge Controller (RNG-CTRL-RVR40)
Overvoltage Shutdown	The default protection voltage is 16V. Improper setting may affect safe use of the battery. Please consult the battery manufacturer and check if this voltage value needs to be modified.
Boost Voltage	This value affects whether the battery can be fully charged. Please consult the battery manufacturer and set the value properly.
Float Voltage	This value affects whether the battery can be fully charged. Please consult the battery manufacturer and set the value properly.
Equalization Voltage	<ol style="list-style-type: none"><li>1. For lead-acid batteries, please consult your battery manufacturer to obtain the voltage value and then complete the settings according to the feedback.</li><li>2. If no equalization is required, set it to the same voltage as Boost.</li></ol>
Undervoltage Warning	This voltage value affects the life of the battery. Consult the battery manufacturer and check if this voltage value needs to be set.
Low Voltage Shutdown	
Low Voltage Reconnect	

# Battery Type



Parameters	Description
Boost Duration	Please consult the battery manufacturer if it is necessary to set these values.
Equalization Duration	
Equalization Interval	

## Setting via the Charge Controller

### NOTE

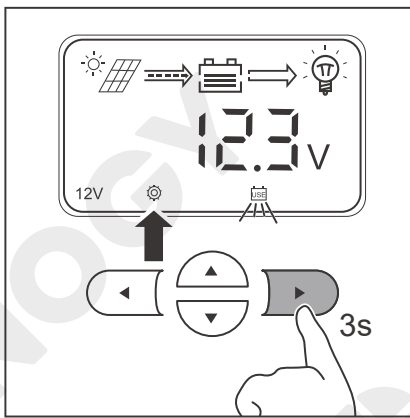
- To cancel the setting and exit, press .



1. Press and hold  on the charge controller for about 3 seconds until  is lit up and the battery type icon starts flashing.

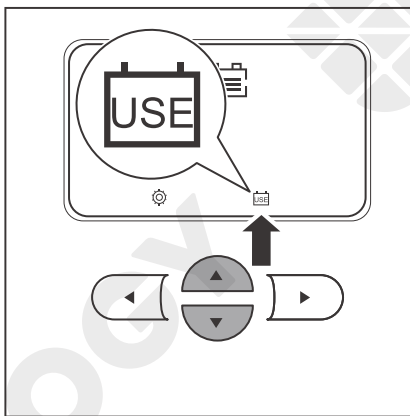

2. Press  or  to select .

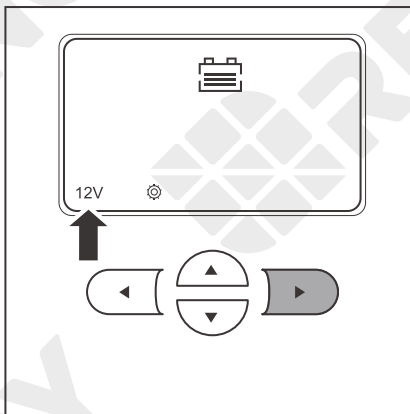

3. Press  to set the system voltage.



# Battery Type

Setting the Battery Type

Battery Charging Parameters

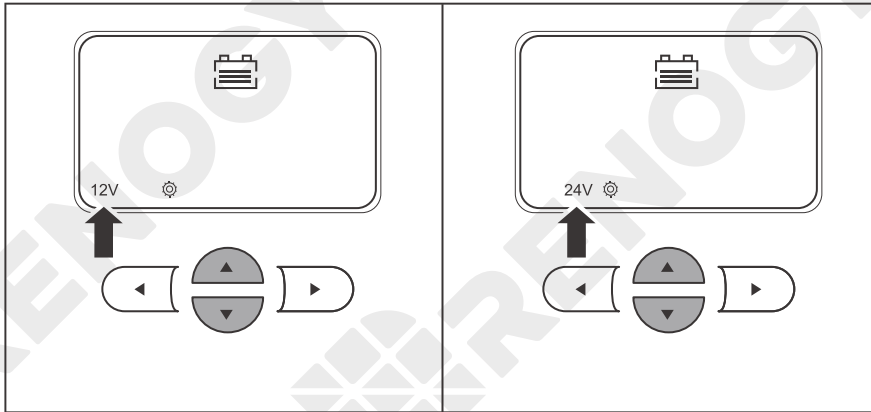
User Mode



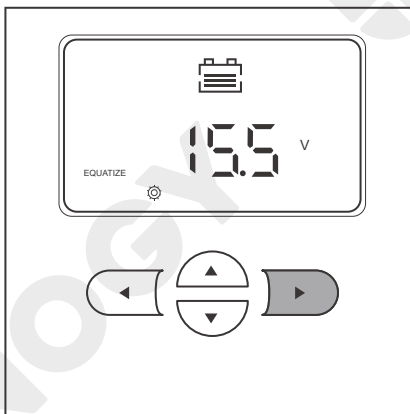

4. Press  or  to select 12V or 24V system voltage according to the usage.

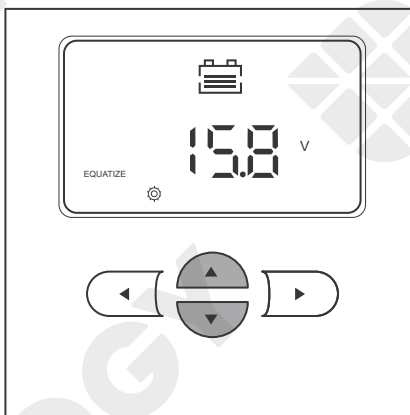

5. Press  to set the equalization voltage.



6. Press  or  to adjust the equalization voltage according to the usage.

## CAUTION

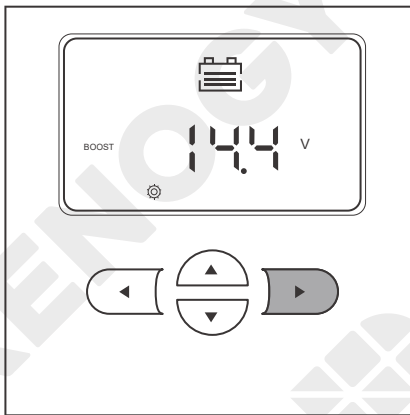

- Overcharging and excessive gas precipitation may damage the battery plates and activate material shedding on them. Too high of an equalization charging voltage or too long of equalization charging may damage the battery. Review the specific requirements of the battery used in the system carefully.
- It is recommended to use only non-sealed, vented, flooded, and wet cell lead acid batteries in the equalization stage.
- Do not equalize VRLA type AGM, gel, and lithium cell batteries unless permitted by battery manufacturers.
- If no equalization is required, set it to the same voltage as Boost.

# Battery Type

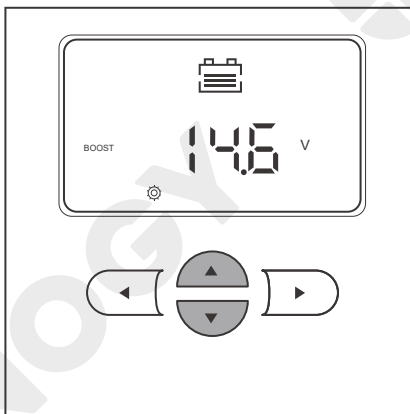

7. Press  to set the boost voltage.



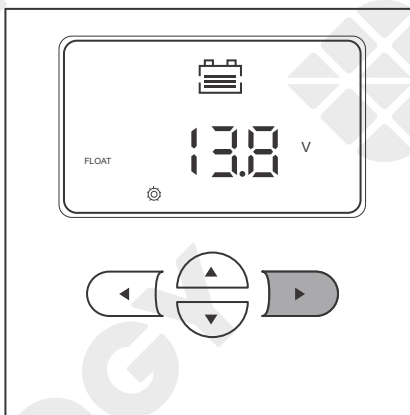

8. Press  or  to adjust the boost voltage according to the usage.

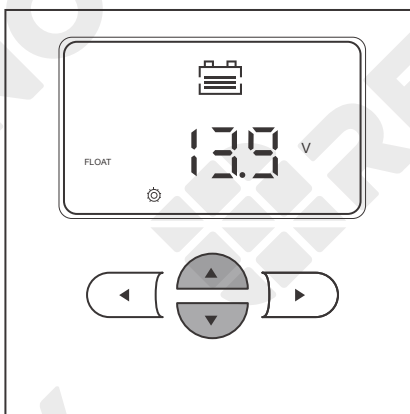

9. Press  to set the float voltage.



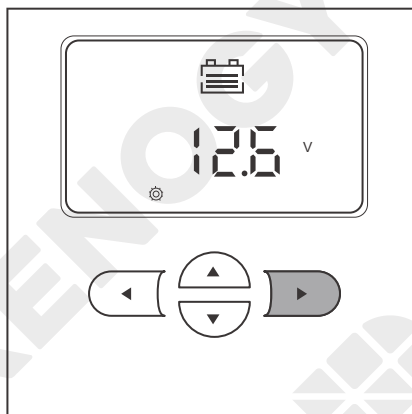

10. Press  or  adjust the float voltage according to the usage.

# Battery Type

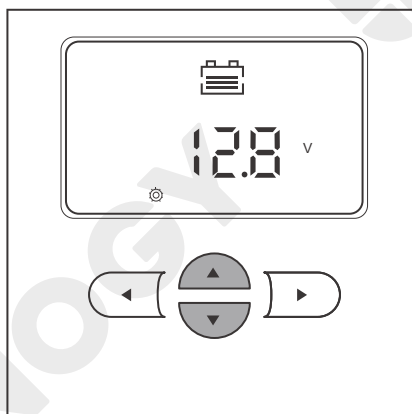

11. Press  to set the overdischarge return voltage.



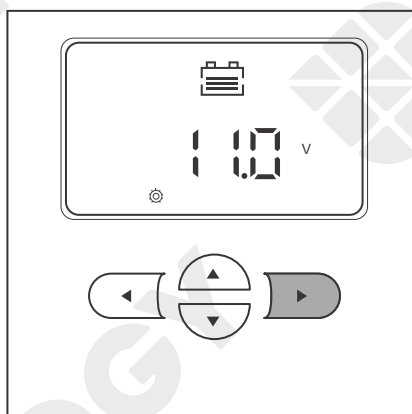

12. Press  or  adjust the overdischarge return voltage according to the usage.



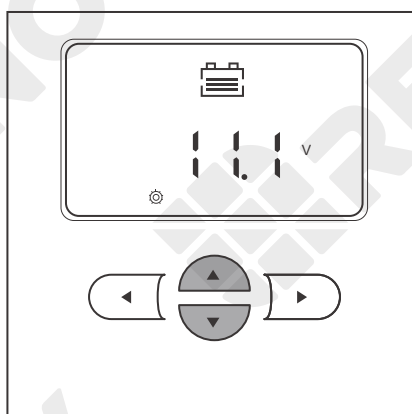

13. Press  to set the overdischarge voltage.

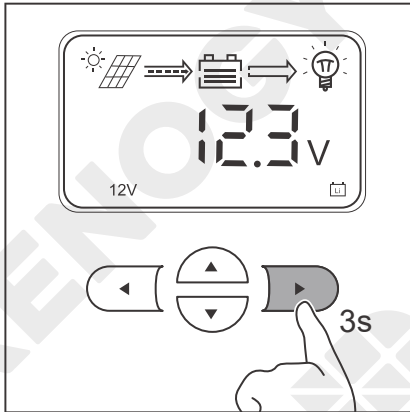

14. Press  or  to adjust the overdischarge voltage according to the usage.

# Battery Type



15. After the settings are completed, press and hold  for about 3 seconds to save the settings.

## Setting via the DC Home app

If the charge controller has been connected to a Renogy BT-1 Bluetooth Module, add the charge controller to the DC Home app first. For more instructions, see the [Bluetooth Module \(Optional\)](#) in the user manual.

### NOTE

- Make sure the Bluetooth of your phone is turned on.
- Make sure the Renogy BT-1 Bluetooth Module is powered on.
- Illustrations of the DC Home app in this user manual are for reference only. Follow the instructions based on the current app version.



1. Tap the charge controller to enter the device details interface.

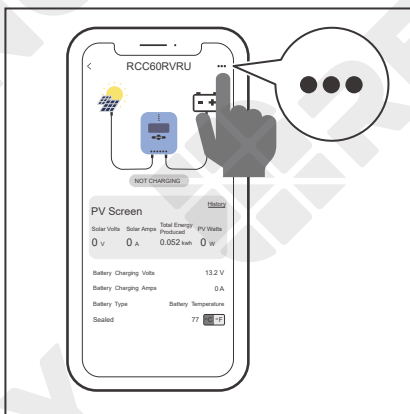

2. Tap  in the upper-right corner.



# Battery Type

Setting the Battery Type

Battery Charging Parameters

User Mode

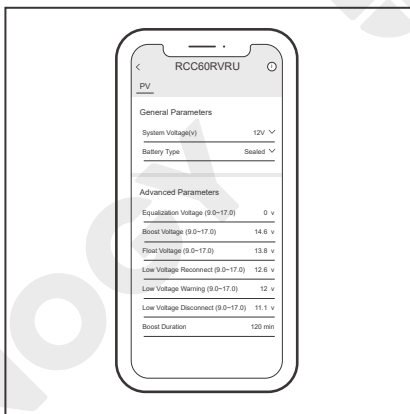

3. Tap **Settings** to enter the mode selection interface.

4. In this interface, you can customize multiple parameters of the battery. When the parameters are modified, **Setting Success** appears on the interface, indicating that the parameter setting is completed.

# System Voltage



The charge controller is simple and easy to use. For common AGM, SLD, gel, and flooded batteries, the charge controller can automatically identify the 12V/24V system voltage.

For the lithium battery, set the system voltage manually.

## NOTE

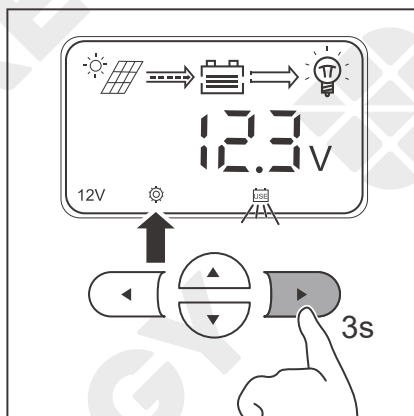
- To cancel the setting and exit, press  .



1. Press and hold  in the main interface for about 3 seconds until  is lit up and the battery type icon starts flashing.

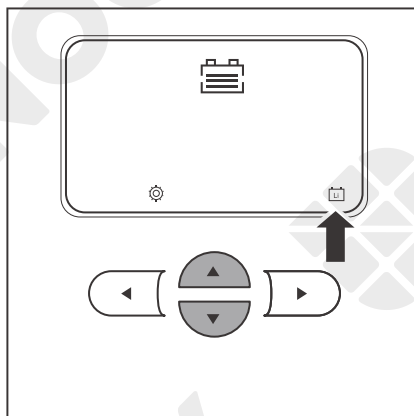

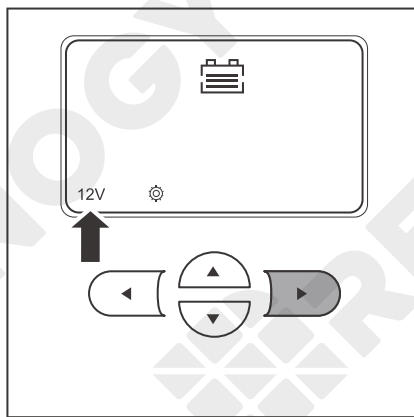

2. Press  or  to select  .



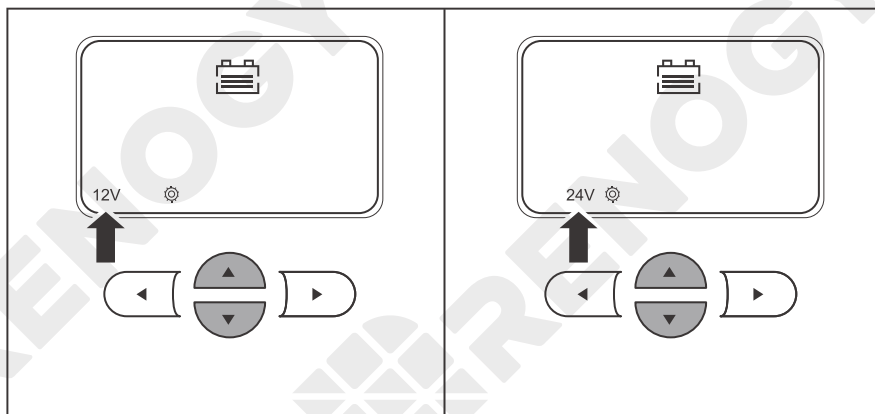

3. Press  to set the system voltage.

# System Voltage

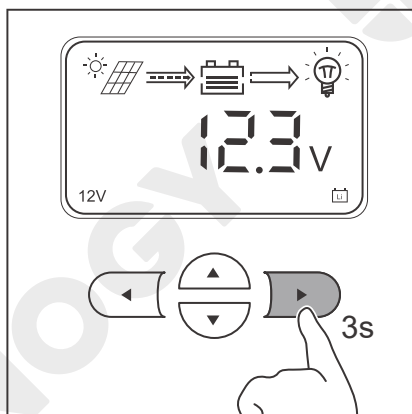

4. Press  or  to select 12V or 24V system voltage according to the usage.



5. After the settings are completed, press and hold  for about 3 seconds to save the settings.

# Monitoring

The charge controller is equipped with a LCD and 4 buttons. You can check the status of the charge controller and set parameters with the buttons.

## Monitoring Menu

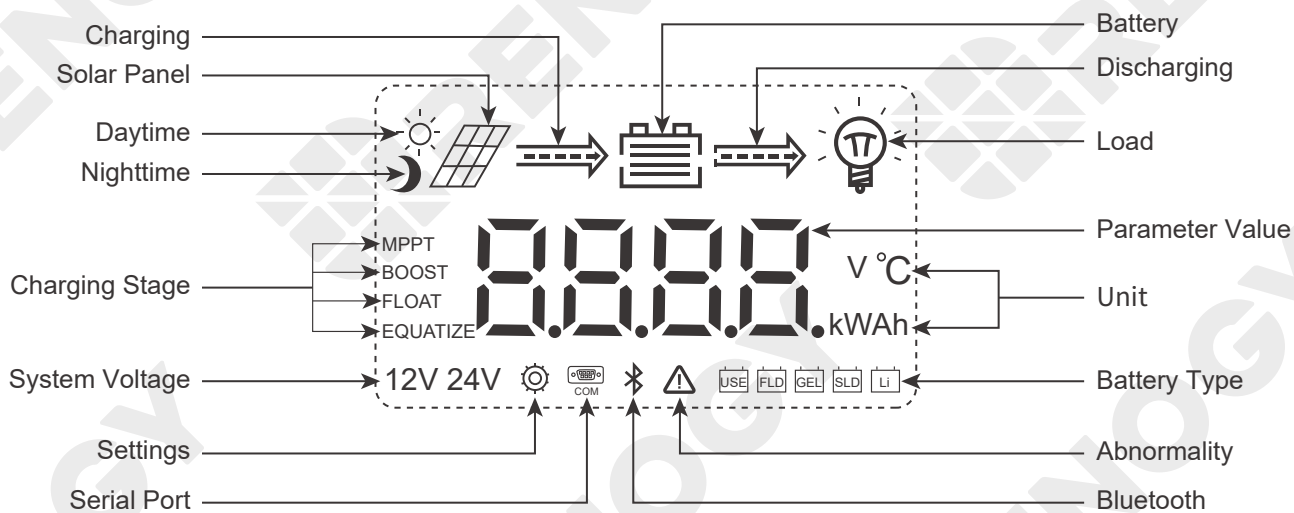







Icon	Parameter	Description
	Daytime Mode	The voltage of the solar panel is greater than or equal to 10V.
	Nighttime Mode	The voltage of the solar panel is less than 10V.
	Charging (The arrow between the solar panel and the battery)	<ul style="list-style-type: none"> <li>• Dynamic: The charge controller is charging the battery.</li> <li>• Static: The charge controller is not charging the battery.</li> </ul>
	Discharging (The arrow between the battery and the load)	<ul style="list-style-type: none"> <li>• Dynamic: The charge controller is powering the load.</li> <li>• Static: The charge controller is not powering the load.</li> </ul>

# Monitoring

Monitoring Menu





Checking Parameters

Icon	Parameter	Description	
	Battery	Indicates four levels of the battery power (based on the battery voltage):	
			0-24%
			25~49%
			50~75%
			75~100%
	Load	The load is powered off or the charge controller is not charging the load.	
		The load is powered on.	
MPPT BOOST FLOAT EQUATIZE	Charging Status	<ul style="list-style-type: none"> <li>• MPPT: The charge controller charges the battery with all the energy from the solar panel.</li> <li>• BOOST: When the battery is charged to the set point of the constant voltage, the charge controller will operate in the constant charging mode. The charging current gradually decreases.</li> <li>• FLOAT: The charge controller charges the battery with a small current to prevent the battery from self-discharging.</li> <li>• EQUATIZE: The charge controller charges the battery at a level higher than the voltage that it is typically charged to remove sulfate crystals that build up on the plates over time and balance the voltage of each cell. Periodic equalization charging is beneficial to certain types of batteries because it helps ensure the battery capacity and maintain its runtime.</li> </ul>	

# Monitoring

Monitoring Menu

















Checking Parameters

Icon	Parameter	Description				
	Value / Unit	 Indicates the parameters of the solar panel or the battery				
		V Indicates the voltage of the solar panel or the battery				
		°C Indicates the temperature of the charge controller or the temperature sensor (if connected)				
		Kw Used by the manufacturer for testing It lights up for a short time when the charge controller is powered on.				
		A Indicates the charging / discharging current of the battery				
	Ah Indicates the charging / discharging current of the battery in an hour					
12V 24V	System Voltage	For non-lithium batteries, the charge controller automatically identifies the voltage (12V or 24V). For lithium batteries, you need to set the voltage in the charge controller manually. For details, see <a href="#">System Voltage</a> . <table border="1" data-bbox="759 1422 1468 1585"> <tr> <td>12V</td> <td>The system voltage is 12V.</td> </tr> <tr> <td>24V</td> <td>The system voltage is 24V.</td> </tr> </table>	12V	The system voltage is 12V.	24V	The system voltage is 24V.
12V	The system voltage is 12V.					
24V	The system voltage is 24V.					
	Setting	Lights up when setting parameters				
 COM	Serial Port	Used by the manufacturer for testing It lights up for a short time when the charge controller is powered on.				
	Bluetooth	Used by the manufacturer for testing It lights up for a short time when the charge controller is powered on.				

# Monitoring

Monitoring Menu

Checking Parameters

Icon	Parameter	Description										
	Abnormality	Fault Check the error code on the LCD.										
	Battery Type	<table border="1"> <tbody> <tr> <td data-bbox="756 495 970 557"></td> <td data-bbox="973 495 1474 557">User-defined battery</td> </tr> <tr> <td data-bbox="756 562 970 624"></td> <td data-bbox="973 562 1474 624">Flooded battery</td> </tr> <tr> <td data-bbox="756 629 970 692"></td> <td data-bbox="973 629 1474 692">Gel battery</td> </tr> <tr> <td data-bbox="756 696 970 759"></td> <td data-bbox="973 696 1474 759">Sealed lead-acid battery</td> </tr> <tr> <td data-bbox="756 763 970 826"></td> <td data-bbox="973 763 1474 826">Lithium battery</td> </tr> </tbody> </table>		User-defined battery		Flooded battery		Gel battery		Sealed lead-acid battery		Lithium battery
	User-defined battery											
	Flooded battery											
	Gel battery											
	Sealed lead-acid battery											
	Lithium battery											

# Monitoring

Monitoring Menu

Checking Parameters

## Checking Parameters

Press  or  to check parameters.

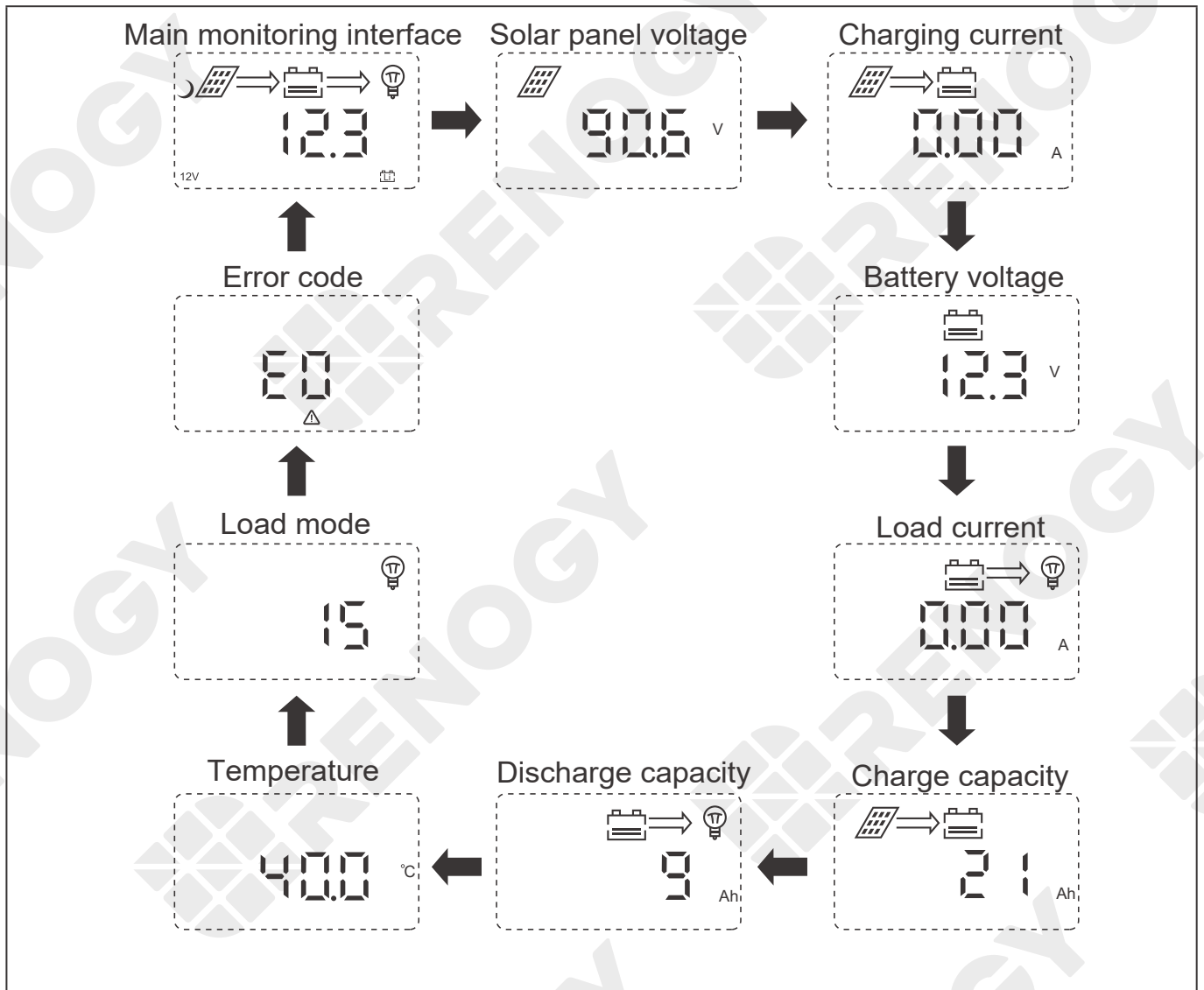
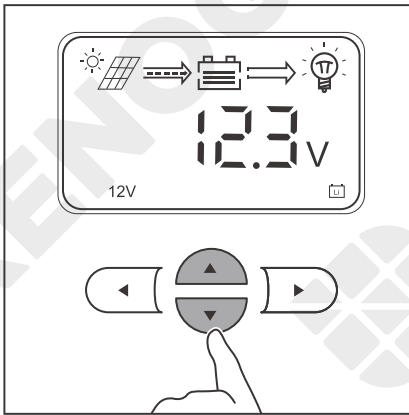





# Load Control

Turning Load On / Off

Switching Load Mode

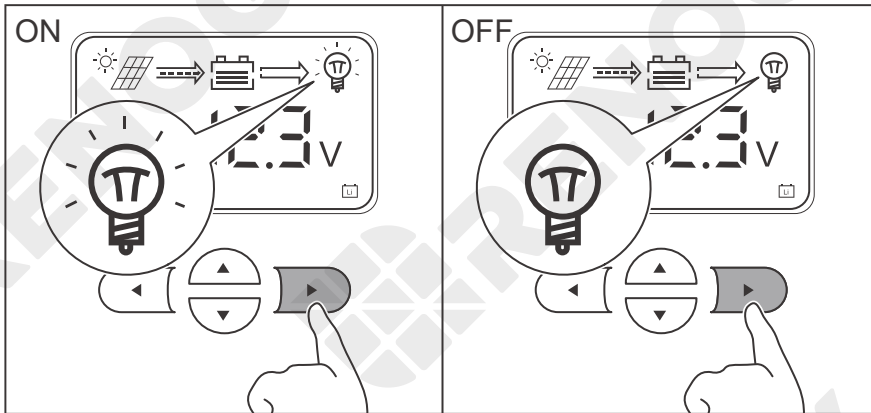
## Turning Load On / Off



If the charge controller is connected to the DC load, press  to turn the load on or off.

## Switching Load Mode

You can set the way to turn on / off the DC load.

### NOTE

- To cancel the setting and exit, press .

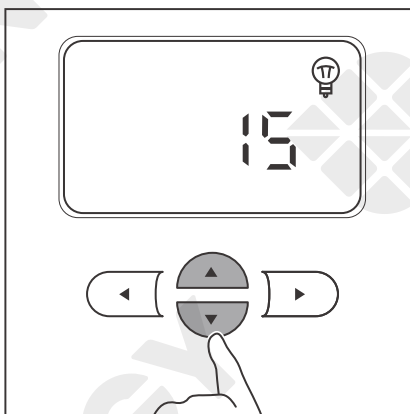

1. Press  or  to select the load mode.

### NOTE

- This interface displays the current load mode.

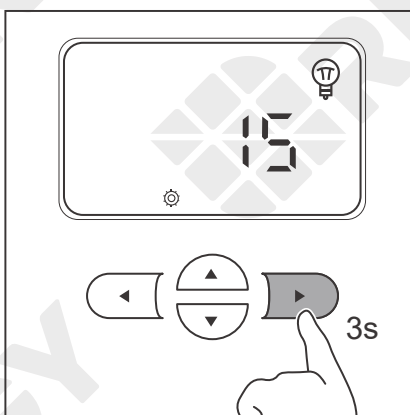



2. Press and hold  for about 3 seconds until  is lit up.

# Load Control

Turning Load On / Off

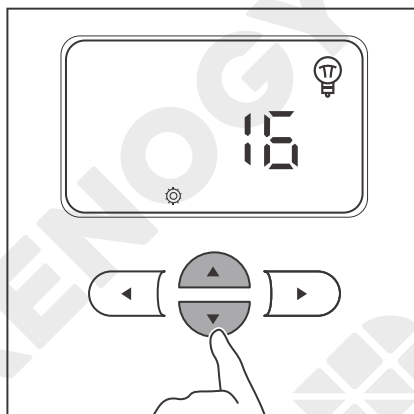
Switching Load Mode



3. Press  or  to adjust the value. Different values indicate the corresponding load modes. You can select the mode according to the table below.

Value	Mode	Description
0	Automatic mode	When the voltage of the solar panel is less than 10V for 5 minutes, the charge controller will automatically supply power to the load. The charge controller will automatically stop supplying power to the load until the solar panel voltage is greater than or equal to 10V or the battery triggers the undervoltage warning.
1-14	Timing mode	This parameter indicates the supply duration in hours. For example, 1 indicates that the charge controller supplies power to the load for an hour. When the solar panel voltage is less than 10V, the charge controller automatically supplies power to the load for 1-14 hours (the time depends on the voltage). If the solar panel voltage is greater than or equal to 10V or the battery triggers the undervoltage warning, the charge controller automatically stops supplying power to the load.
15	Manual mode	Factory default mode Press  to turn the on / off the load.
16	No delay mode	When the solar panel voltage is less than 10V, the charge controller immediately supplies power to the load. The charge controller will automatically stop supplying power to the load until the solar panel voltage is greater than or equal to 10V or the battery triggers the undervoltage warning.
17	24-hour mode	The charge controller keeps supplying power to the load until the battery triggers the undervoltage warning.

# Load Control

Turning Load On / Off

Switching Load Mode

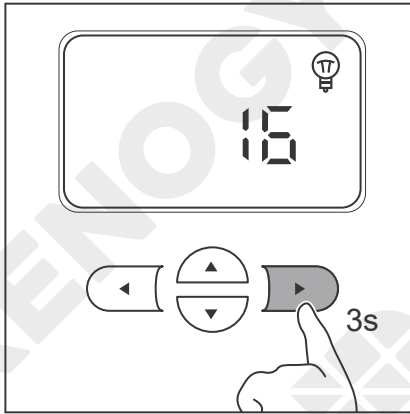

4. After the settings are completed, press and hold  for about 3 seconds to save the settings.





# LED Indicators

Solar Panel LED Indicator







Battery LED Indicator

Load LED Indicator

System Error LED Indicator

Indicator	Description	Function
	Solar Panel LED Indicator	Indicates the charging status of the charge controller
	Battery LED Indicator	Indicates the working status of the battery
	Load LED Indicator	Indicates the working status of the load
	System Error LED Indicator	Indicates whether the charge controller is operating normally When the charge controller is faulty, the indicator lights up.

## Solar Panel LED Indicator

Indicator	Color	Status	Description
	White 	ON	The solar panel is charging the battery.
	White 	Slow flash for 1s	The charge controller is in the boost charging stage.
	White 	Single flash	The charge controller is in the float charging stage.
	White 	Flash for 0.1s	The charge controller is in the equalization charging stage.
	White 	Double flash	The solar panel is charging the battery slowly. The current is too low. Make sure that the solar panel is not covered.
	/ 	OFF	The voltage of the solar panel is too low or the solar panel is not detected.

# LED Indicators





Solar Panel LED Indicator

Battery LED Indicator





Load LED Indicator

System Error LED Indicator



## Battery LED Indicator

Indicator	Color	Status	Description
	White 	ON	The battery is operating normally.
	White 	Slow flash for 1s	The battery is overdischarging. Charge the battery as soon as possible.
	White 	Flash for 0.1s	The battery voltage is too high. Disconnect the battery from the charge controller and check whether the battery is damaged.
	/ 	OFF	No battery is detected.

## Load LED Indicator

Indicator	Color	Status	Description
	White 	ON	The load is powered on.
	White 	Flash for 0.1s	Overload or short circuit. At the same time, the System Error LED Indicator lights up. Check the error code for troubleshooting. For more details, see <a href="#">Troubleshooting</a> in the user manual.
	/ 	OFF	The load is powered off.

## System Error LED Indicator

Indicator	Color	Status	Description
	White 	ON	Fault For more details, see <a href="#">Troubleshooting</a> in the user manual.
	/ 	OFF	The charge controller is operating normally.

# Troubleshooting

Common Faults

Fault Codes

## Common Faults

Fault	Troubleshooting
<p>The solar panel is connected, but the LED indicator of the solar panel can not light up.</p>	<p>This indicates the solar panel voltage may be too low or the panel cannot be detected by the charge controller. Follow the troubleshooting steps below:</p> <ol style="list-style-type: none"><li>1. Inspect the solar panel for any visible damage and make sure it works normally. If the voltage of the solar panel is too low at night, check it again during the day.</li><li>2. Inspect the solar panel and keep it away from the shelter.</li><li>3. Make sure the voltage of the solar panel is higher than the battery voltage. Otherwise, the solar panel cannot charge the battery.</li><li>4. Identify the polarities (positive and negative) on the cables used for the solar panel. A reverse polarity contact will cause the charge controller to work abnormally.</li><li>5. Make sure the cables of the solar panel are properly connected to the PV+ and PV- of the charge controller.</li><li>6. Inspect the cable of the solar panel for any visible damage.</li><li>7. Inspect the fuse of the solar panel for any visible damage.</li></ol> <p>For technical support, please contact our customer service through <a href="http://renogy.com/contact-us/">renogy.com/contact-us/</a>.</p>
<p>The battery is connected. However, the indicators of the charge controller LCD and battery LED can not light up.</p>	<p>The battery needs troubleshooting if it can not be detected. Follow the troubleshooting steps below:</p> <ol style="list-style-type: none"><li>1. Inspect the battery and replace it with a new one if it has any visible damage.</li><li>2. Measure the battery voltage with a multimeter and make sure the system voltage of the battery is 12V or 24V. Otherwise, the battery can not be detected by the charge controller.</li><li>3. Identify the polarities (positive and negative) on the cables used for the battery. A reverse polarity contact will cause the charge controller to work abnormally.</li><li>4. Make sure the cable of the battery is properly connected to the BAT+ and BAT- of the charge controller.</li><li>5. Inspect the cable of the battery for any visible damage.</li><li>6. Inspect the fuse of the battery for any visible damage.</li></ol> <p>For technical support, please contact our customer service through <a href="http://renogy.com/contact-us/">renogy.com/contact-us/</a>.</p>

# Troubleshooting

Fault	Troubleshooting
<p>The charging current of the charge controller or the solar panel current is lower than expected</p>	<ol style="list-style-type: none"> <li>1. The charge controller is in the float charging stage, and the charging current will gradually drop until the battery is fully charged.</li> <li>2. Inspect the solar panel and keep it away from the shelter.</li> <li>3. Check whether the sunlight intensity is high enough.</li> <li>4. If the temperature of the charge controller is too high, the error code will not be displayed. Shut down the charge controller until the temperature drops to a standard value.</li> <li>5. Select the appropriate cables and fuses according to the <a href="#">Recommended Cable and Fuse Sizing</a> in this manual.</li> <li>6. The voltage drops because the Solar Panel Extension Cable is too long.</li> </ol>
<p>ACT displays over 1 to 2 days</p>	<ol style="list-style-type: none"> <li>1. Identify the polarities (positive and negative) on the cables used for the battery. A reverse polarity contact will cause the charge controller to work abnormally. Connect the battery first and then the solar panel. Otherwise, the charge controller may be damaged.</li> <li>2. Measure the voltages of the battery, BAT+, and BAT- of the charge controller with a multimeter. If the voltages are inconsistent, the circuit is interrupted. Inspect the circuit and the battery fuse for any visible damage or incorrect connection.</li> <li>3. The preset battery voltage is incorrect. Measure the battery voltage with a multimeter, and then reset the system voltage according to the actual use. For details, refer to <a href="#">System Voltage</a> in this user manual. Disconnect the battery from the charge controller and reconnect to it to activate the battery.</li> <li>4. The discharging speed of the battery is faster than the charging speed. Turn off or disconnect the load of the battery and charge the battery immediately to prevent the lithium battery from triggering BMS protection due to low voltage.</li> </ol> <p>After the voltage of the lithium battery is restored, the battery will automatically exit the activation mode and work normally.</p>

# Troubleshooting

Common Faults

Fault Codes

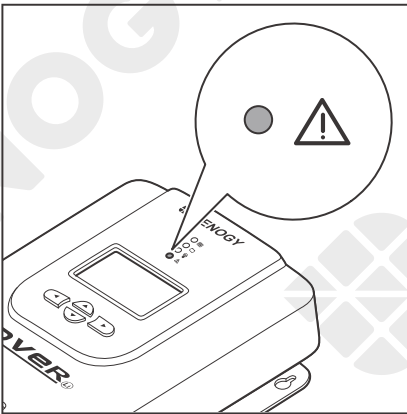

Fault	Troubleshooting
<p>The load cannot be powered on after connection.</p>	<ol style="list-style-type: none"> <li>1. Identify the polarities (positive and negative) on the cables used for the battery. A reverse polarity contact will cause the load to work abnormally.</li> <li>2. Make sure the load cables are properly connected.</li> <li>3. Ensure that the load works normally. If the load is damaged, replace it with a new one.</li> <li>4. Check the load mode. For details, refer to <a href="#">Switching Load Mode</a> in this manual.</li> <li>5. Check the battery voltage. If the battery voltage is too low, charge the battery immediately.</li> </ol>

## Error Codes

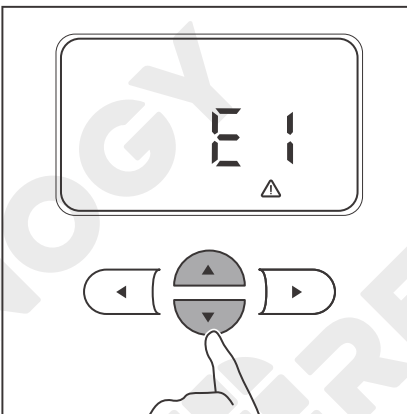

1. Under normal conditions, the System Error LED Indicator of the charge controller will not light up.



2. Press  or  enter the fault codes interface. Perform troubleshooting according to steps listed in the table below.







Icon	Description	Troubleshooting
	<p>No fault is detected</p>	<p>The charge controller works normally.</p>



# Troubleshooting

Common Faults



Fault Codes

Icon	Description	Troubleshooting
	Battery overdischarge	Measure the battery voltage with a multimeter. If the battery voltage is too low, disconnect the load from the battery and charge the battery.
	Battery overcharge	Measure the battery voltage with a multimeter. If the battery voltage is too high, disconnect the battery from the charge controller and replace the battery with a new one.
	Load short circuit	<p>Follow the troubleshooting steps below:</p> <ol style="list-style-type: none"> <li>1. Disconnect the load. Measure the load voltage with a multimeter and ensure that the load voltage matches the battery voltage.</li> <li>2. Make sure the load is properly connected.</li> <li>3. Inspect the load for any visible damage.</li> <li>4. Disconnect the battery from the charge controller and restart the charge controller.</li> <li>5. If the fault code remains, replace the load with a new one.</li> </ol> <p>For technical support, please contact our customer service through <a href="https://renogy.com/contact-us/">renogy.com/contact-us/</a>.</p>
	Load overload	<ol style="list-style-type: none"> <li>1. Check the load voltage. If the system voltage of the charge controller is 12V, the load port can only be connected with the 12V DC load. Otherwise, connect the load port with the 24V DC load.</li> <li>2. The maximum current of the load port on the charge controller is 20A. Ensure that the rated load charge current does not exceed 20A.</li> </ol>
	Charge controller overtemperature	<p>Follow the troubleshooting steps below:</p> <ol style="list-style-type: none"> <li>1. Short press  or  to check the temperature. If the temperature is too high, disconnect all devices from the charge controller immediately.</li> <li>2. Ensure that the charge controller is installed on a flat surface indoors protected from direct sunlight, high temperature, and water.</li> <li>3. Make sure there is good ventilation.</li> <li>4. Select the appropriate cables and fuses according to the <a href="#">Recommended Cable and Fuse Sizing</a> in this manual.</li> <li>5. Reconnect the charge controller after the temperature drops to a standard value.</li> </ol>

# Troubleshooting

Common Faults

Fault Codes

Icon	Description	Troubleshooting
	Solar panel overcurrent	<ol style="list-style-type: none"><li>1. Make sure the solar panel is not short circuited.</li><li>2. Ensure that the power of the solar panel does not exceed the rated power of the charge controller.</li></ol>
	Solar panel overvoltage	The maximum DC input voltage of the charge controller is 100V. Make sure the voltage of the solar panel array is less than or equal to 100V. Otherwise, reduce the number of solar panels.

## NOTE

- For technical support, please contact our customer service through [renogy.com/contact-us/](https://renogy.com/contact-us/).

# Technical Specifications

Parameter	Value		
Model	RNG-CTRL -RVR20	RNG-CTRL -RVR30	RNG-CTRL -RVR40
Rated Battery Input Voltage	Non-lithium: 12V/24V (automatic recognition) Lithium: 12V/24V (manual setting)		
Battery Input Voltage Range	10V to 32V DC		
Rated Charge Current	20A	30A	40A
Rated Load Charge Current	20A		
Rated Solar Input Power	12V @ 260W	12V @ 400W	12V @ 520W
	24V @ 520W	24V @ 800W	24V @ 1040W
Maximum Solar Input Power	520W	800W	1040W
Maximum Solar Input Voltage (Voc)	100V DC		
Solar Input Voltage Range (Voc)	15V to 100V DC		
Power Consumption	≤100mA @12V		
	≤58mA @24V		
MPPT Tracking Efficiency	>99%		
Conversion Efficiency	≤98%		
Charger Efficiency	>95%		
MPPT Operating Voltage Range	17V to 100V DC		
Temperature Compensation	Non-lithium: -3mV / °C / 2V Lithium: 0mV / °C / 2V; no compensation		
Charger Algorithm	Lead acid battery: 3-stage charging (Bulk, Boost, and Float) with Equalization Lithium batteries: 2-stage charging (Bulk and Boost)		
Charger Preset	AGM, Gel, Flooded, Li, User-defined		
Cable Size	8 AWG to 12 AWG	8 AWG to 10 AWG	6 AWG to 8 AWG
Grounding	Common Negative		
Communication	RS232 Modbus		
Operating Temperature	-31°F to 113°F / -35°C to 45°C		

# Technical Specifications

Parameter	Value	
Storage Temperature	-31°F to 167°F or -35°C to 75°C	
Humidity	0% to 95% RH	
Maximum Operating Altitude	≤3000m	
Cooling	Heat Sink	
Enclosure Rating	IP32	
Dimensions (L x W x H)	8.27 x 5.95 x 2.69 in 210 x 151 x 68 mm	9.38 x 6.78 x 3.05 in 238 x 172 x 77 mm
Weight	3.1 lbs / 1.4 kg	4.4 lbs / 2.0 kg
Regulatory and Safety Specifications	FCC Part 15 Class B, CE, RoHS, RCM	

# MPPT Conversion Efficiency

Light Intensity: 1000W/m<sup>2</sup>

Temperature: 25°C

### MPPT 12V conversion efficiency (12V battery)

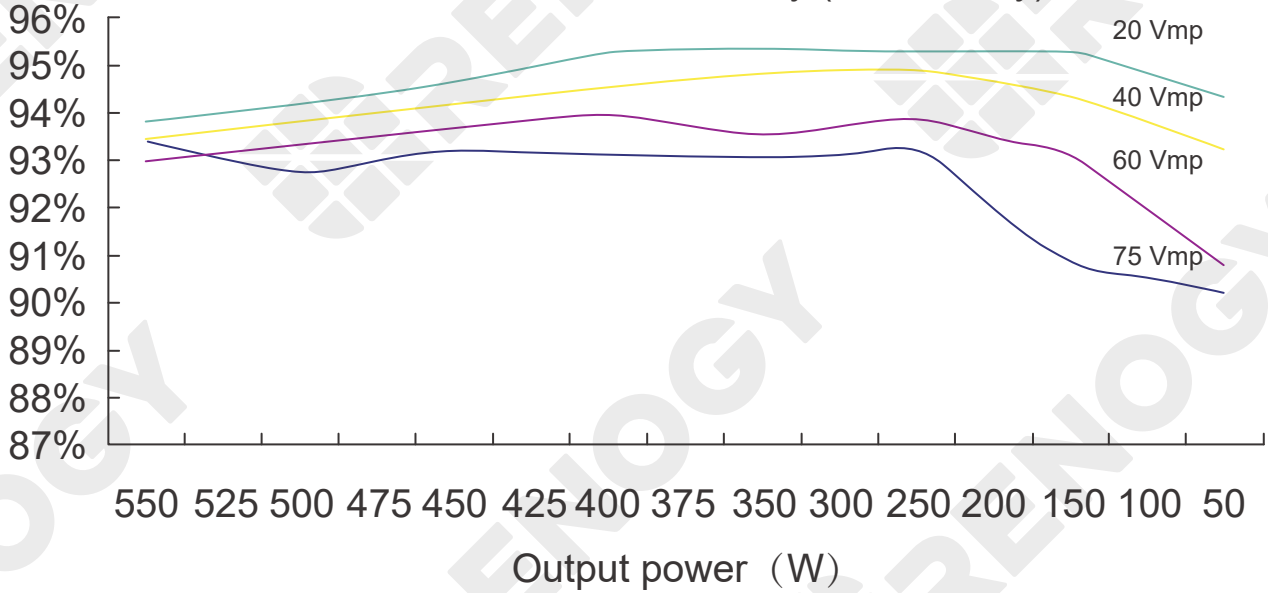

### MPPT 24V conversion efficiency (24V battery)

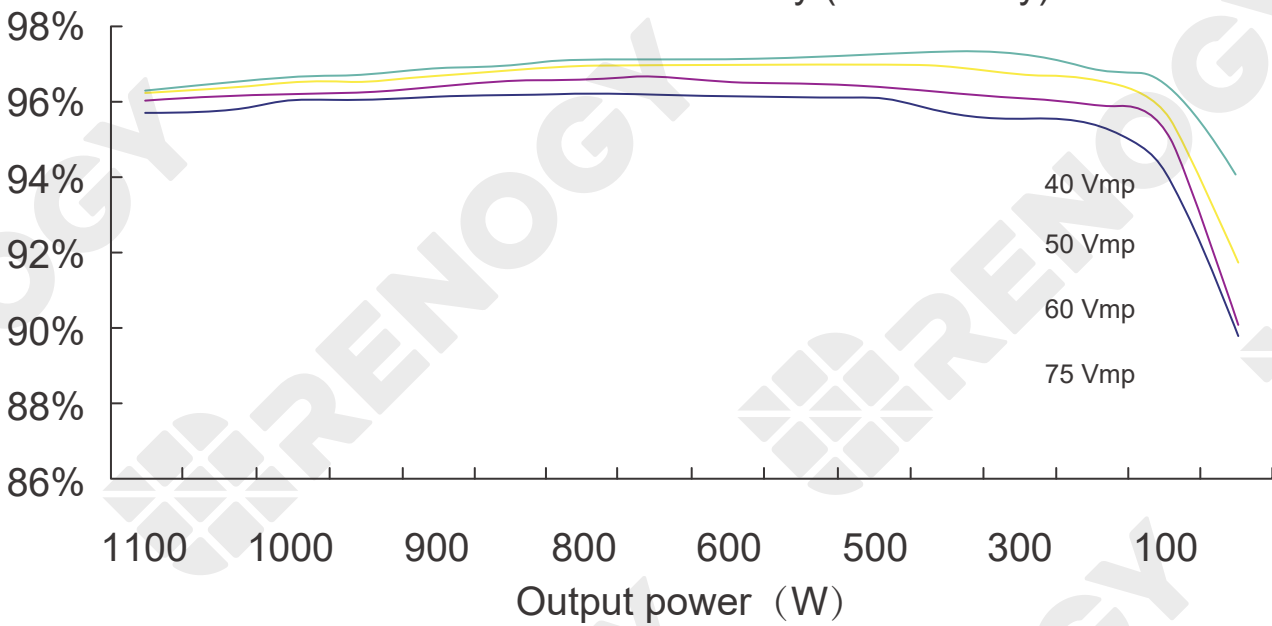

# Dimensions

RNG-CTRL-RVR20

RNG-CTRL-RVR30 or RNG-CTRL-RVR40

## RNG-CTRL-RVR20

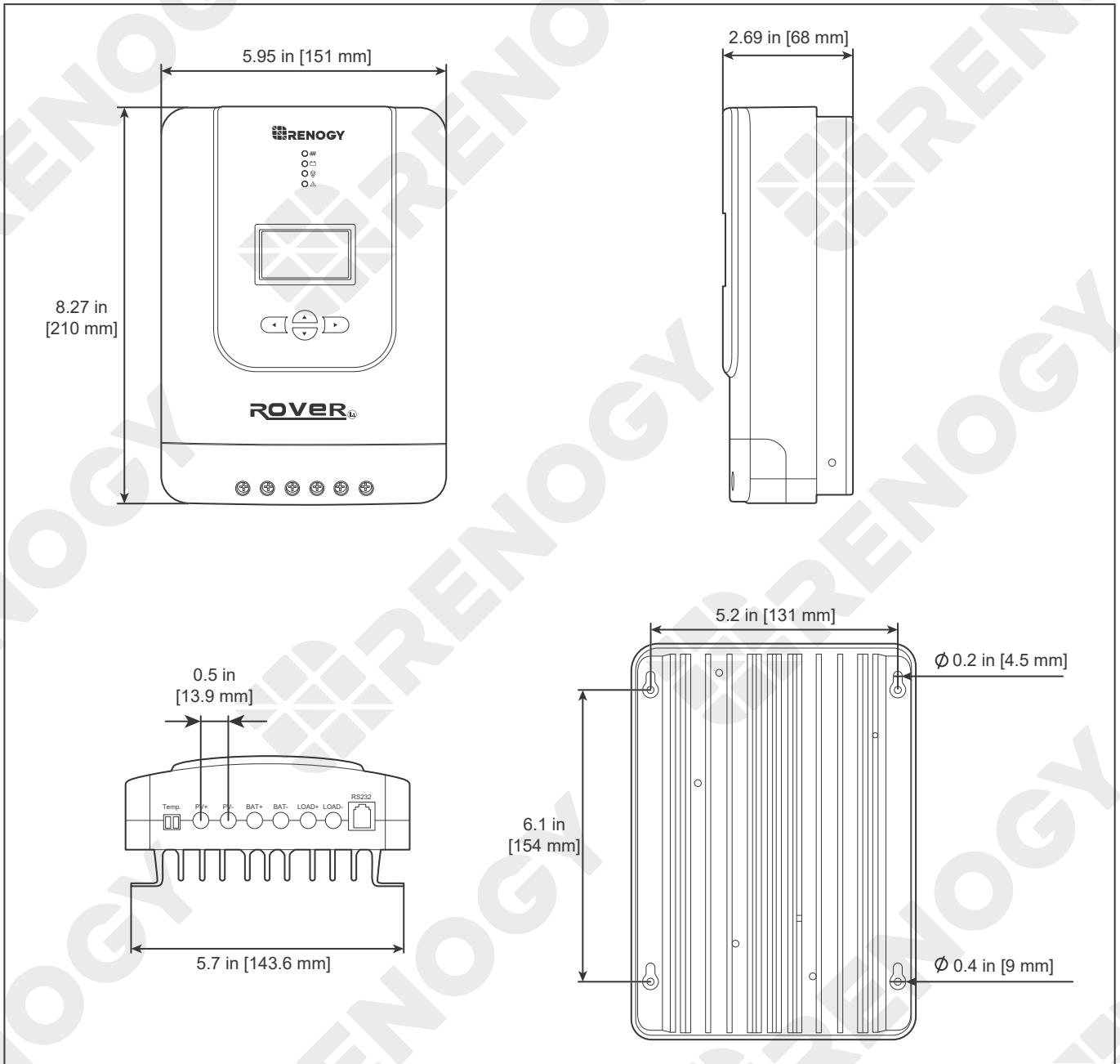

### **i** NOTE

- Dimension tolerance:  $\pm 0.2$  in (0.5 mm)

# Dimensions

RNG-CTRL-RVR20

RNG-CTRL-RVR30 or RNG-CTRL-RVR40

## RNG-CTRL-RVR30 or RNG-CTRL-RVR40

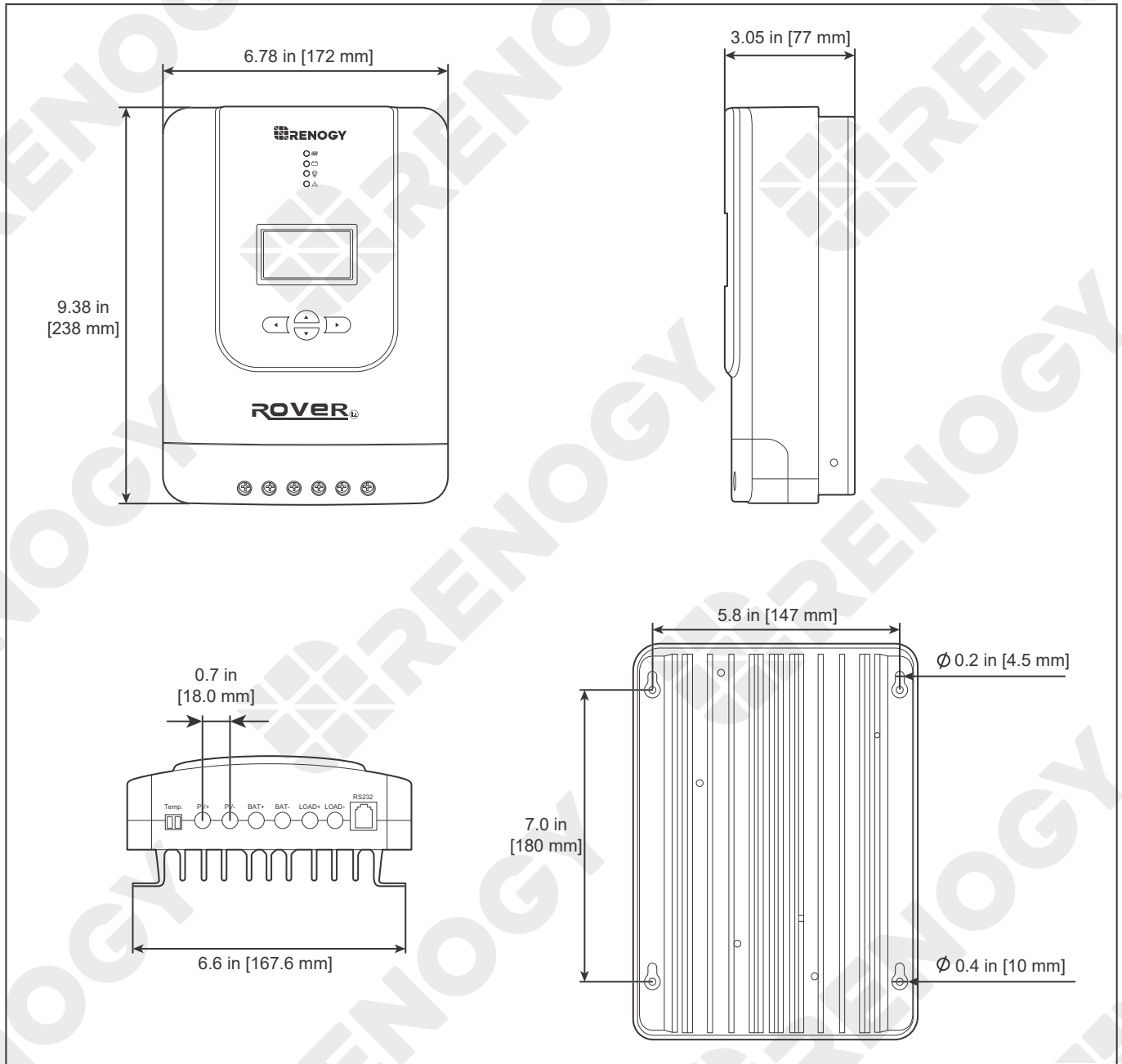

### **i** NOTE

- Dimension tolerance:  $\pm 0.2$  in (0.5 mm)

# Maintenance

Inspection

Cleaning

Storage

## Inspection

For optimum performance, it is recommended to perform these tasks regularly.

- Check the appearance of the charge controller to make sure it is clean and dry.
- Ensure the charge controller is mounted in a clean, dry, and ventilated area.
- Ensure there is no damage or wear on the cables. Ensure the firmness of the Anderson connectors and check if there are any loose, damaged or burnt connections.
- Make sure that the indicators are in normal state.
- Ensure there is no corrosion, insulation damage, or discoloration marks of overheating or burning.



### NOTE

- In some applications, corrosion may exist around the contacts inside the Anderson connector.

Corrosion can loosen springs and increase resistance, leading to premature connection failure. Apply dielectric grease to each connector contact periodically. Dielectric grease repels moisture and protects the connector contacts from corrosion.



### WARNING

- Risk of electric shock! Make sure that all power is turned off before touching the terminals on the charge controller.

## Cleaning

Follow the steps below to clean the charge controller regularly.

- Disconnect all Anderson connectors that are connected to the charge controller.
- Wipe the housing and connector contacts with a dry cloth or non-metallic brush. If it is still dirty, you can use household cleaners.
- Dry the charge controller with a clean cloth and keep the area around the charge controller clean and dry.
- Make sure the charge controller is completely dry before reconnecting it to the solar panel and the battery.
- When reconnecting, the battery must be connected first, then the solar panel.

## Storage

Follow the tips below to ensure that the charge controller is stored well.

- Disconnect all Anderson connectors that are connected to the charge controller.
- By applying dielectric grease to each connector contact, the dielectric grease repels moisture and protects the connector contacts from corrosion.
- Store the charge controller in a well-ventilated, dry and clean environment with a temperature between -13°F and 149°F.



# Emergency Responses

Fire

Flooding

Smell

Noise

In the event of any threat to health or safety, always begin with the steps below before addressing other suggestions.

- Immediately contact the fire department or other relevant emergency response team.
- Notify all people who might be affected and ensure that they can evacuate the area.

## **WARNING**

- ONLY perform the suggested actions below if it is safe to do so.

### Fire

1. Disconnect all cables connected to the charge controller.
2. Put out the fire with a fire extinguisher. Acceptable fire extinguishers include water, CO<sub>2</sub>, and ABC.

## **WARNING**

- Do not use type D (flammable metal) fire extinguishers.

### Flooding

1. If the charge controller is submerged in water, stay away from the water.
2. Disconnect all cables connected to the charge controller.

### Smell

1. Disconnect all the cables from the charge controller.
2. Ensure that nothing is in contact with the charge controller.
3. Ventilate the room.

### Noise

1. Disconnect all cables connected to the charge controller.
2. Make sure no foreign objects are stuck in the Anderson connector.

# Technical Support

For additional support, contact the Renogy technical support team through [renogy.com/contact-us](https://www.renogy.com/contact-us). Have the following information available when contacting Renogy.

- Owner name
- Contact information
- Order number
- Purchase channel
- Serial number
- Brief description of the issue



**Renogy offers premium services worldwide:**

<b>North America</b>	US	<a href="https://www.renogy.com">www.renogy.com</a>	CN	<a href="https://www.renogy.cn">www.renogy.cn</a>
<b>Asia / Pacific</b>	UK	<a href="https://uk.renogy.com">uk.renogy.com</a>	CA	<a href="https://ca.renogy.com">ca.renogy.com</a>
	AU	<a href="https://au.renogy.com">au.renogy.com</a>	JP	<a href="https://renogy.jp">renogy.jp</a>
<b>Europe</b>	FR	<a href="https://fr.renogy.com">fr.renogy.com</a>	DE	<a href="https://de.renogy.com">de.renogy.com</a>
	ES	<a href="https://es.renogy.com">es.renogy.com</a>	KR	<a href="https://kr.renogy.com">kr.renogy.com</a>

## FCC Statement

This device complies with Part 15 of the FCC Rules. FCC ID: 2ANPBRSMPLP4-G2. Operation is subject to the following two conditions:

- (1) This device may not cause harmful interference.
- (2) This device must accept any interference received, including interference that may cause undesired operation.

This equipment has been tested and found to comply with the limits for a Class B digital device, pursuant to Part 15 of the FCC Rules. These limits are designed to provide reasonable protection against harmful interference in a residential installation. This equipment generates, uses and can radiate radio frequency energy and, if not installed and used in accordance with the instructions, may cause harmful interference to radio communications. However, there is no guarantee that interference will not occur in a particular installation. If this equipment does cause harmful interference to radio or television reception, which can be determined by turning the equipment off and on, the user is encouraged to try to correct the interference by one or more of the following measures:

- (1) Orient or relocate the receiving antenna.
- (2) Increase the separation between the equipment and receiver.
- (3) Connect the equipment into an outlet on a circuit different from that to which the receiver is connected.
- (4) Consult the dealer or an experienced radio / TV technician for help.

## FCC Radiation Exposure Statement

This equipment complies with FCC radiation exposure limits set forth for an uncontrolled environment. This equipment should be installed and operated with minimum distance 20 cm between the radiator & your body.

Visit [renogy.com](https://renogy.com) to find relevant documentation or get more support via "[Contact Us](#)".  
Renogy reserves the right to change the contents of this manual without notice.

Manufacturer: RENOGY New Energy Co.,Ltd  
Address: No.66, East Ningbo Road Room 624-625  
Taicang German Overseas Students Pioneer Park  
JiangSu 215000 CN



eVatmaster Consulting GmbH  
Battinastr.30  
60325 Frankfurt am Main, Germany  
contact@evatmaster.com

Manufacturer: RENOGY New Energy Co.,Ltd  
Address: No.66, East Ningbo Road Room 624-625  
Taicang German Overseas Students Pioneer Park  
JiangSu 215000 CN



EVATOST CONSULTING LTD  
Suite 11, First Floor, Moy Road Business  
Centre, Taffs Well, Cardiff, Wales, CF15 7QR  
contact@evatmaster.com

Join the Renogy Power Plus Community  
by downloading the DC Home App.  
Find your e-warranty here, and more.

